

We first started with manufacturing "Cutting Tools" in 1980 and continued with the production of various parts until 1996 when **Metsan Makina Yedek Parça Ltd. Şti.** was founded. Our production is principally focused on tractor replacement parts such as Hydraulic Pumps, Hydraulic Steerings, Balancers, Oil Pumps and Distributors since 2001. Our main objective is to offer our customers a product that is O.E. like in quality and presentation, at a price that is more affordable. Because of our client-centric enterprise philosophy we try to answer all our customer's requests. Therefore we are always willing to include new items to our product range or to produce against technical drawings and/or samples according our customer's demand.

Empezamos primero con la fabricación de "Herramientas de corte" en 1980 y continuamos con la producción de diversas piezas hasta 1996 cuando se fundó **Metsan Makina Yedek Parça Ltd. Şti.** fue fundada. Nuestra producción se centra principalmente en las piezas de repuesto para tractores, como bombas hidráulicas, direcciones hidráulicas, equilibradores, bombas de aceite y distribuidores desde 2001. Nuestro principal objetivo es ofrecer a nuestros clientes un producto que es como producto original en calidad y presentación, a un precio más asequible. Debido a nuestra filosofía empresarial centrada en el cliente, intentamos responder a todas las peticiones de nuestros clientes. Por lo tanto, siempre estamos dispuestos a incluir nuevos artículos en nuestra gama de productos o a producir contra dibujos técnicos y/o muestras según la demanda de nuestros clientes.

1980 senesinde kesici takımlar ile imalata başlayan ve 1996'da **Metsan Makina Yedek Parça Ltd. Şti.** olarak faaliyetlerine devam eden firmamız 2001 senesinden bu yana traktör yedek parçası üretmektedir. Firmamız, otuzun üzerinde makina tezgahı ile Hidrolik Pompa, Hidrolik Direksiyon Kutusu, Balansiyer, Yağ Pompası ve Distribütör imalatına ağırlık vermiş olup sektörün ihtiyacına yönelik özel imalat da yapmaktadır. Metsan Makina, gerek yüksek teknoloji yatırımı gerekse tecrübeli personeli ile değerli müşterilerimize en iyi hizmet ve kaliteyi sunmayı kendine hedef edinmiştir.



MTSCO Dış Ticaret Ltd.Şti. was founded in 2014 to export Metsan Makina products. Along with Metsan Makina spare parts we supply quality aftermarket parts cooperating with 85 local manufacturers. With 70 employees at METSAN MAKINA and 5 employees at MTSCO Dış Ticaret our main target is CUSTOMER SATISFACTION, PRODUCT DEVELOPMENT and LONG TERM BUSINNES. We distribute 15.000 fast moving Quality Spare Parts to 25 country's increased by simultaneous NEW Products monthly.

MTSCO Dış Ticaret Ltd.Şti. fue fundada en 2014 para exportar los productos de Metsan Makina. Junto con las piezas de recambio de Metsan Makina, suministramos piezas de recambio de calidad cooperando con 85 fabricantes locales. Con 70 empleados en METSAN MAKINA y 5 empleados en MTSCO Dış Ticaret nuestro principal objetivo es la SATISFACCIÓN DEL CLIENTE, el DESARROLLO DEL PRODUCTO y los NEGOCIOS A LARGO PLAZO. Distribuimos 15.000 piezas de repuesto de calidad en movimiento rápido a 25 países, incrementado por nuevos productos simultáneos mensualmente.

MTSCO Dış Ticaret Ltd.Şti., Metsan Makina'nın yurt dışı satışlarını yapmak üzere 2014 senesinde kurulmuştur. Metsan Makina yedek parçalarının yanı sıra 85 yerel üretici ile işbirliği yaparak kaliteli satış sonrası parçalar tedarik ediyoruz. METSAN MAKİNA'da 70 ve MTSCO Dış Ticaret'te 5 çalışmamız ile ana hedefimiz MÜŞTERİ MEMNUNİYETİ, ÜRÜN GELİŞTİRME ve UZUN VADELİ BİR SÜREÇTİR. Her ay 15.000 adet hızlı hareket eden kaliteli yedek parçayı 25 ülkeye eş zamanlı dağıtımını gerçekleştiriyoruz.

Replacement Tractor Parts Piezas de Repuesto del Tractor Traktör Yedek Parçaları

MTSCO Ref.	Part Numbers Números de Pieza Orijinal Parça No.	Description Descripción Ürün Tanımı	Photo Fotografía Fotoğraf
------------	--	---	---------------------------------

AR103034 and AR103036 HYDRAULIC PUMP PARTS AR103034 y AR103036 PIEZAS DE BOMBA HIDRÁULICA AR103034 ve AR103036 HİDROLİK POMPA PARÇALARI

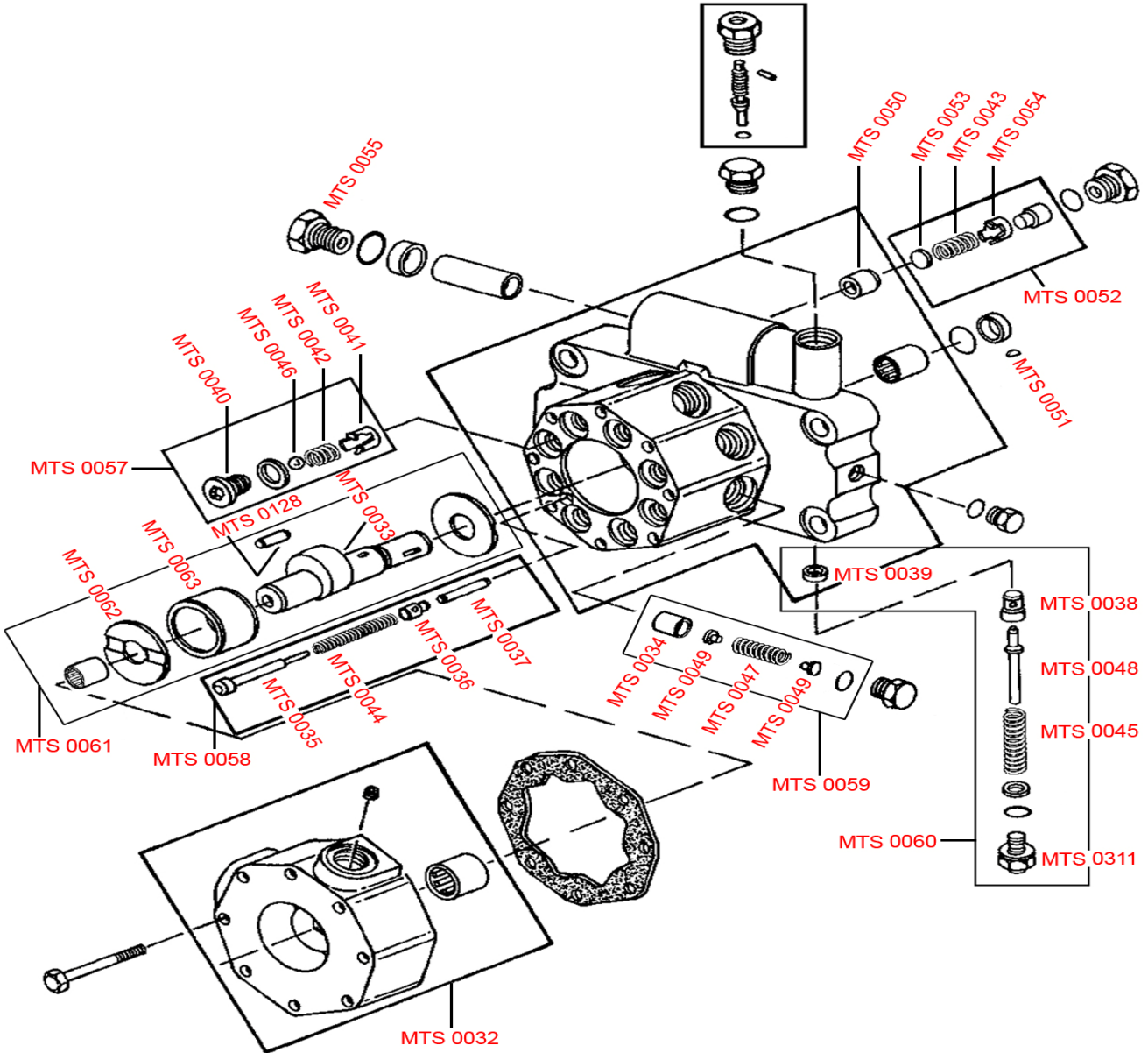



Replacement Tractor Parts

Piezas de Repuesto del Tractor

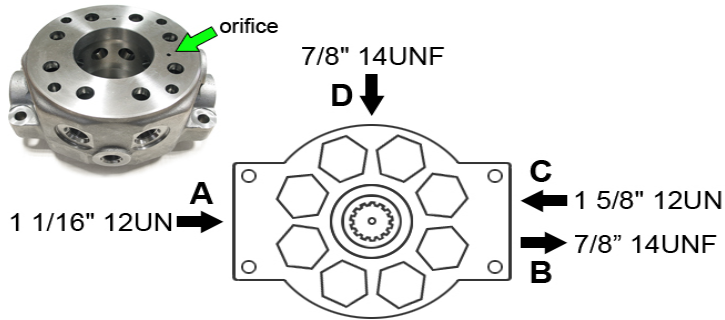

Traktör Yedek Parçaları

MTSCO Ref.	Part Numbers Números de Pieza Orijinal Parça No.	Description Descripción Ürün Tanımı	Photo Fotografía Fotoğraf
John Deere MTS 0029	AR103036 AR103033	HYDRAULIC PUMP with 8 pistons BOMBA HİDRÁULICA de 8 Pistones HİDROLİK POMPA 8 PİSTONLU	
John Deere MTS 0028	AR103034 AR39018 AR39167 AR89063	HYDRAULIC PUMP with 4 pistons BOMBA HİDRÁULICA de 4 Pistones HİDROLİK POMPA 4 PİSTONLU	
John Deere MTS 0031	AR39170 AR89075	HYDRAULIC PUMP HOUSING 8 pistons type CUERPO DE BOMBA HIDRÁULICA para el tipo de 8 Pistones HİD.POMPA 8 PS BOŞ GÖVDE	
John Deere MTS 0030	AR39169 AR89076	HYD.PUMP HOUSING 4 pistons type CUERPO DE BOMBA HIDRÁULICA para el tipo 4 Pistones HİD.POMPA 4 PS BOŞ GÖVDE	
John Deere MTS 0032	AR90453	HYDRAULIC PUMP COVER CUBIERTA DE LA BOMBA HIDRÁULICA HİD.POMPA KAPAĞI	

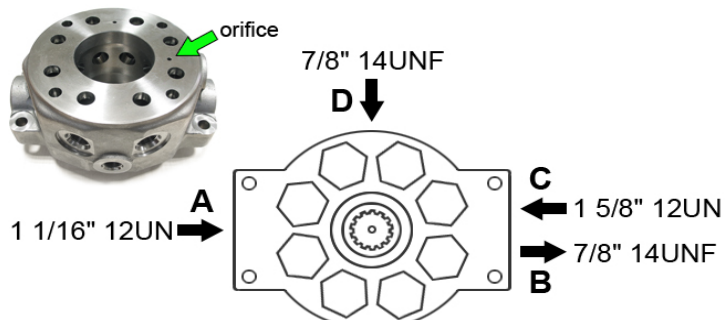

MTSCO Ref.	Part Numbers Números de Pieza Orijinal Parça No.	Description Descripción Ürün Tanımı	Photo Fotografía Fotoğraf
------------	--	---	---------------------------------

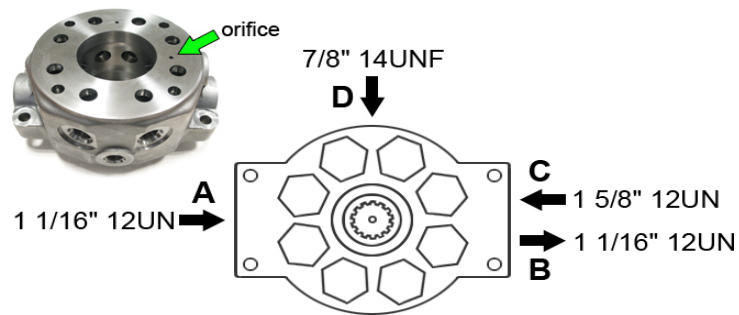
John Deere	MTS 0340	AR90459 AR97872	<p>HYDRAULIC PUMP 40cm³ / 2.4 in³</p> <p>BOMBA HIDRÁULICA 40cm³ / 2.4 en³</p> <p>B.HİDROLİK POMPA 40cm³ / 2.4 in³</p>	
				
John Deere	MTS 0341	AR94660 AR56161	<p>HYDRAULIC PUMP 50cm³ / 3 in³</p> <p>BOMBA HIDRÁULICA 50cm³ / 3 en³</p> <p>B.HİDROLİK POMPA 50cm³ / 3 in³</p>	
				

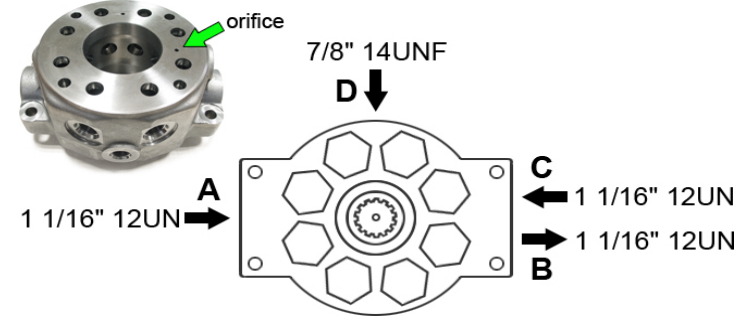
MTSCO Ref.	Part Numbers Números de Pieza Orijinal Parça No.	Description Descripción Ürün Tanımı	Photo Fotografía Fotoğraf
------------	--	---	---------------------------------

John Deere	MTS 0342	AR101807 RE13377	<p>HYDRAULIC PUMP 50cm³ / 3 in³</p> <p>BOMBA HIDRÁULICA 50cm³ / 3 en³</p> <p>B.HİDROLİK POMPA 50cm³ / 3 in³</p>	
				
John Deere	MTS 0343	AR94661 AR99839 AR70722 AR73106 AR46246 RE20839 R71587	<p>HYDRAULIC PUMP 65cm³ / 4 in³</p> <p>BOMBA HIDRÁULICA 65cm³ / 4 en³</p> <p>B.HİDROLİK POMPA 65cm³ / 4 in³</p>	
				

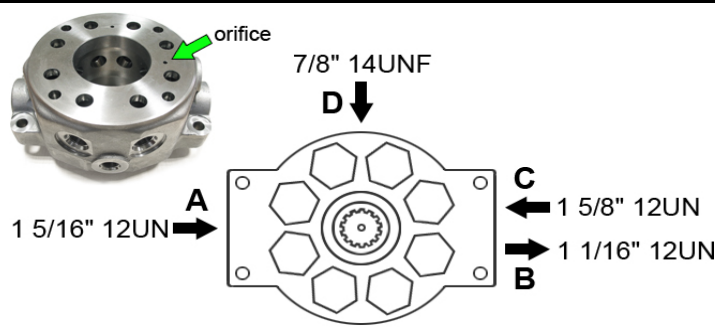
MTSCO Ref.	Part Numbers Números de Pieza Orijinal Parça No.	Description Descripción Ürün Tanımı	Photo Fotografía Fotoğraf
------------	--	---	---------------------------------

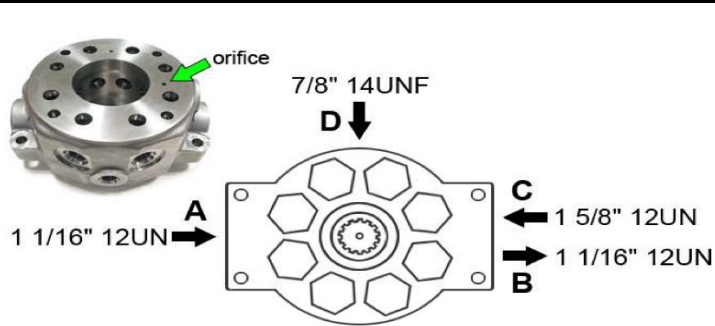
John Deere	MTS 0344	AR101288 AR52952 AR99845	<p>HYDRAULIC PUMP 65cm³ / 4 in³</p> <p>BOMBA HIDRÁULICA 65cm³ / 3 en³</p> <p>B.HİDROLİK POMPA 65cm³ / 4 in³</p>	
				
John Deere	MTS 0500	AR97872-M	<p>HYDRAULIC PUMP 40cm³ / 2.4 in³</p> <p>BOMBA HIDRÁULICA 40cm³ / 2.4 en³</p> <p>B.HİDROLİK POMPA 40cm³ / 2.4 in³</p>	
				



MTSCO[®]

Parts Manufacturing

Replacement Tractor Parts

Piezas de Repuesto del Tractor

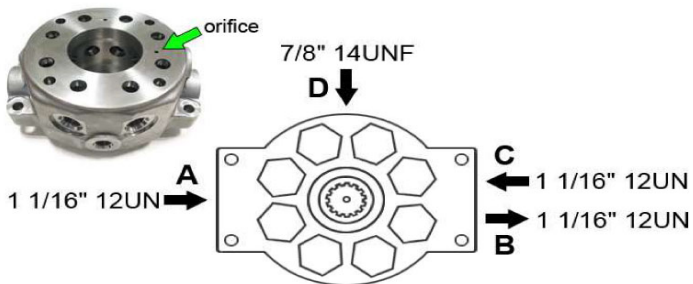
Traktör Yedek Parçaları

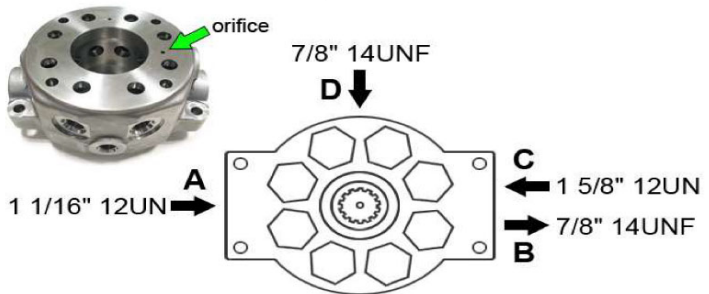
MTSCO Ref.	Part Numbers Números de Pieza Orijinal Parça No.	Description Descripción Ürün Tanımı	Photo Fotografía Fotoğraf
John Deere MTS 0501	AR94660-M	HYDRAULIC PUMP 50cm ³ / 3 in ³ BOMBA HIDRÁULICA 50cm ³ / 3 en ³ B.HİDROLİK POMPA 50cm ³ / 3 in ³	
			
John Deere MTS 0502	AR56160-M	HYDRAULIC PUMP 50cm ³ / 3 in ³ BOMBA HIDRÁULICA 50cm ³ / 3 en ³ B.HİDROLİK POMPA 50cm ³ / 3 in ³	
		Port C is closed with a plug. El puerto C se cierra con un tapón. C portu kör tapa ile kapatılmıştır.	



MTSCO[®]

Parts Manufacturing

Replacement Tractor Parts

Piezas de Repuesto del Tractor

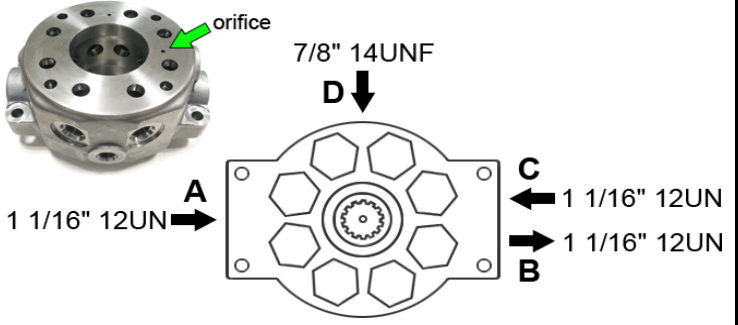

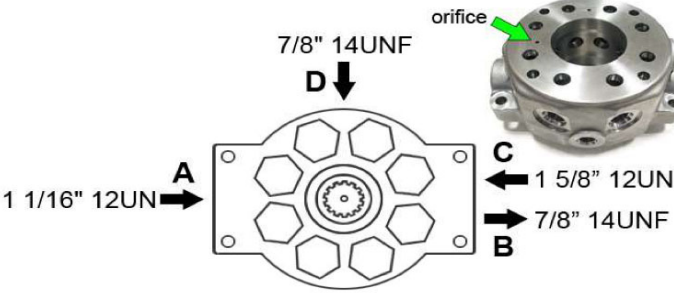

Traktör Yedek Parçaları

MTSCO Ref.	Part Numbers Números de Pieza Orijinal Parça No.	Description Descripción Ürün Tanımı	Photo Fotografía Fotoğraf
John Deere MTS 0503	AR91661-M D port with O'ring channel. The pump casing is not ducted, instead there is a duct and O'ring on the crank. Puerto D con canal O'ring. La carcasa de la bomba no está canalizada, en su lugar hay un conducto y una junta tórica en el cigüeñal. D portu O'ring kanallı. Pompa gövdesi kanalsız, onun yerine Krank üzerinde kanal ve O'ring mevcuttur.	HYDRAULIC PUMP 65cm ³ / 4 in ³ BOMBA HIDRÁULICA 65cm ³ / 4 en ³ B.HİDROLİK POMPA 65cm ³ / 4 in ³	
		 <p>7/8" 14UNF D ↓ A ← 1 1/16" 12UN B → 1 1/16" 12UN C ← 1 1/16" 12UN orifice</p>	
John Deere MTS 0504	AR56160-M1 Port C is closed with a blind plug. There is also a port on the cover for the electric closing unit. El puerto C se cierra con un tapón ciego. También hay un puerto en la tapa para la unidad de cierre eléctrico. C portu kör tapa ile kapatılmıştır. Elektirikli kapama ünitesi için, kapak üzerinde ayrıca port vardır.	HYDRAULIC PUMP 50cm ³ / 3 in ³ BOMBA HIDRÁULICA 50cm ³ / 3 en ³ B.HİDROLİK POMPA 50cm ³ / 3 in ³	
		 <p>7/8" 14UNF D ↓ A ← 1 1/16" 12UN B → 7/8" 14UNF C ← 1 5/8" 12UN orifice</p>	

Replacement Tractor Parts

Piezas de Repuesto del Tractor





Traktör Yedek Parçaları

MTSCO Ref.	Part Numbers Números de Pieza Orijinal Parça No.	Description Descripción Ürün Tanımı	Photo Fotografía Fotoğraf
John Deere MTS 0359	R38714	HYDRAULIC PUMP BODY 40cm ³ CUERPO DE BOMBA HIDRÁULICA 40cm ³ B.HİD.POMPA BOŞ GÖVDE 40cm ³	
John Deere MTS 0360	RE12470	HYDRAULIC PUMP BODY 50cm ³ CUERPO DE BOMBA HIDRÁULICA 50cm ³ B.HİD.POMPA BOŞ GÖVDE 50cm ³	
John Deere MTS 0506	RE16582	HYDRAULIC PUMP with 8 pistons DT BOMBA HIDRÁULICA de 8 Pistones DT HİDROLİK POMPA 8 PİSTONLU DT	
John Deere MTS 0371	AR39052	HYDRAULIC PUMP OIL SEAL RETÉN PARA BOMBA HIDRÁULICA HİD.POMPA KEÇESİ	
John Deere MTS 26303	FOR AR103033 AR103036 PARA AR103033 AR103036 İÇİN AR103033 AR103035	HYD.PUMP REPAIR KIT JUEGO DE REPARACIÓN DE LA BOMBA HIDRÁULICA HİD.POMPA TAM TAMİR TK.	

Replacement Tractor Parts

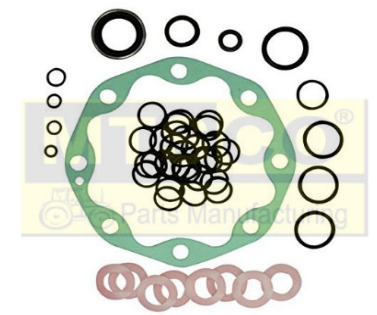
Piezas de Repuesto del Tractor

Traktör Yedek Parçaları

MTSCO Ref.	Part Numbers Números de Pieza Orijinal Parça No.	Description Descripción Ürün Tanımı	Photo Fotografía Fotoğraf
John Deere MTS 1062	FOR AR103033 AR103036 PARA AR103033 AR103036 İÇİN AR103033 AR103036	HYD.PUMP REP.KIT WITHOUT GASKET REPARACIÓN DE LA BOMBA HIDRÁULICA SIN JUNTA KIT HİDROLİK POMPA TAMİR KİTİ CONTASIZ	
John Deere MTS 26300	AR39052KIT R63605KIT	HYD.PUMP SEAL KIT, for 11 or 23cm3 pumps KIT DE JUNTAS DE BOMBA HIDRÁULICA , para bombas de 11 o 23cm3 HİDROLİK POMPA KEÇE TM.TK. 11 ve 23cm3	
John Deere MTS 0086	RE228042 AR39156 AR98993	HYDRAULIC PUMP SEAL KIT JUEGO JUNTAS (SELLOS) BOMBA HIDRÁULICA HİD.POM.O'RING TM.TK.	
John Deere MTS 0369	L62442 R39178 R59234	HYDRAULIC PUMP COVER GASKET JUNTA CIERRE DE LA TAPA DE LA BOMBA HIDRÁULICA HİD.POMPA KAPAK CONTASI	
John Deere MTS 0437	R63605	HYD.PUMP PACKING QUAD RING ANILLO DE GOMA DE LA BOMBA HIDRÁULICA HİD.POMPA YONCA O'RINGI	

Replacement Tractor Parts

Piezas de Repuesto del Tractor

Traktör Yedek Parçaları

MTSCO Ref.	Part Numbers Números de Pieza Orijinal Parça No.	Description Descripción Ürün Tanımı	Photo Fotografía Fotoğraf
John Deere MTS 0061	AL35755	HYDRAULIC PUMP CRANKSHAFT KIT KİT DE REPARACIÓN DE BOMBA HÍDRÁULICA HİD.POMPA KRANK TK.	
John Deere MTS 0368	AR89072	HYD.PUMP CYL.ROLLER BEARING RULEMAN DE AGUJAS DE BOMBA HÍDRÁULICA HİD.POMPA MASURA RULMANI	
John Deere MTS 0033	R39319 R39177 R39172	HYDRAULIC PUMP CRANKSHAFT FLECHA O CIGÜEÑAL PARA BOMBA HÍDRÁULICA HİD.POMPA KRANK MİLİ	
John Deere MTS 0128	R39073	HYD.PUMP C.SHAFT NEEDLE ROLLER UNA AGUJA DE BOMBA HÍDRÁULICA HİD.POMPA KRANK MİLİ MASURA	
John Deere MTS 0062	R66164 R39016	HYD.PUMP C.SHAFT THRUST WASHER ARANDELA DE BOMBA HÍDRÁULICA HİD.POMPA KRANK MİLİ PULU	

Replacement Tractor Parts

Piezas de Repuesto del Tractor

Traktör Yedek Parçaları

MTSCO Ref.	Part Numbers Números de Pieza Orijinal Parça No.	Description Descripción Ürün Tanımı	Photo Fotografía Fotoğraf
John Deere MTS 0063	R39017 R63629	HYD.PUMP C.SHAFT BEARING RACE PISTA DE AGUJAS DE BOMBA HÍDRÁULICA HÍD.POMPA KRANK BURCU	
John Deere MTS 0050	R39067 R105583	HYDRAULIC PUMP VALVE SEAT ASIENTO VÁLVULA BOMBA HÍDRÁULICA HÍD.POMPA ARA VALFİ	
John Deere MTS 0051	26H77	HYDRAULIC PUMP C.SHAFT KEY CHAVETA DEL EJE DE LA BOMBA HÍDRÁULICA HÍD.POMPA KRANK KAMASI	
John Deere MTS 0052	AR52785 AR96613 RE23382	HYDRAULIC PUMP VALVE, OUTLET VÁLVULA DE ALIVIO BOMBA HÍDRÁULICA HÍD.POMPA BASINÇ VALF TK.	
John Deere MTS 0043	R39228	HYDRAULIC PUMP VALVE SPRING RESORTE DE LA BOMBA HÍDRÁULICA HÍD.POMPA BASINÇ VALF YAYI	

Replacement Tractor Parts

Piezas de Repuesto del Tractor

Traktör Yedek Parçaları





MTSCO Ref.	Part Numbers Números de Pieza Orijinal Parça No.	Description Descripción Ürün Tanımı	Photo Fotografía Fotoğraf
John Deere MTS 0053	R49297	HYDRAULIC PUMP VALVE DISK ASIENTO VÁLVULA DÍSCO HİD.POMPA TAZYİK VALF PULU	
John Deere MTS 0054	R48738	HYDRAULIC PUMP VALVE GUIDE GUÍA DE LA VÁLVULA DE LA BOMBA HÍDRÁULICA HİD.POMPA BASINÇ VALF TK.SACI	
John Deere MTS 0057	AL71016	HYDRAULIC PUMP VALVE, INLET LA VÁLVULA DE ENTRADA DE BOMBA HÍDRÁULICA HİD.POMPA EMİŞ VALF TK.	
John Deere MTS 0040	R68553 R39075	HYD.PUMP VALVE SEAT INSERT ASIENTO DE VÁLVULA BOMBA HÍDRÁULICA HİD.POMPA BASINÇ REKORU	
John Deere MTS 0041	R39076	HYDRAULIC PUMP VALVE GUIDE GUÍA MUELLE DE VÁLVULA BOMBA HÍDRÁULICA HİD.POMPA TAZYİK MAŞASI	

MTSCO Ref.	Part Numbers Números de Pieza Orijinal Parça No.	Description Descripción Ürün Tanımı	Photo Fotografía Fotoğraf
John Deere MTS 0042	R39078	HYDRAULIC PUMP VALVE SPRING RESORTE DE VÁLVULA BOMBA HIDRÁULICA HİD.POMPA BASINÇ REKOR YAYI	
John Deere MTS 0046	D2361R	HYDRAULIC PUMP VALVE BALL BOLA DE VÁLVULA BOMBA HIDRÁULICA HİD.POMPA REKOR MİSKETİ	
John Deere MTS 0058	AL71017	HYDRAULIC PUMP VALVE, BYPASS DERIVACIÓN VÁLVULA BOMBA HIDRÁULICA HİD.POMPA BYPASS TK.	
John Deere MTS 0035	R39181	HYDRAULIC PUMP VALVE GUIDE GUÍA DE VÁLVULA DE BOMBA HIDRÁULICA HİD.POMPA VALFI	
John Deere MTS 0044	R68390 R31630	HYDRAULIC PUMP VALVE SPRING RESORTE DE VÁLVULA DE BOMBA HIDRÁULICA HİD.POMPA BASINÇ YAYI	

MTSCO Ref.	Part Numbers Números de Pieza Orijinal Parça No.	Description Descripción Ürün Tanımı	Photo Fotografía Fotoğraf
John Deere MTS 0036	R39180	HYDRAULIC PUMP VALVE CARCASA DE BOMBA VÁLVULA DE SALIDA HİD.POMPA VALF İĞNE YATAĞI	
John Deere MTS 0037	R39179	HYDRAULIC PUMP NEEDLE ROLLER PASADOR CILINDRO BOMBA HIDRÁULICA HİD.POMPA VALF PİMİ	
John Deere MTS 0059	AL71018	HYDRAULIC PUMP PISTON KIT JUEGO DE PISTONES PARA BOMBA HIDRÁULICA HİD.POMPA PİSTON TK.	
John Deere MTS 0034	R39068 R63022 R63629	HYDRAULIC PUMP PISTON STD. ÉMBOLO / PISTÓN DE BOMBA HIDRÁULICA HİD.POMPA PİSTONU STD.	
John Deere MTS 0049	R39070	HYDRAULIC PUMP PISTON GUIDE GUÍA DE RESORTE DE PISTÓN DE BOMBA HIDRÁULICA HİD.POMPA BASINÇ PERÇİNİ	

MTSCO Ref.	Part Numbers Números de Pieza Orijinal Parça No.	Description Descripción Ürün Tanımı	Photo Fotografía Fotoğraf
John Deere MTS 0047	AR39041	HYDRAULIC PUMP PISTON SPRING RESORTE DE PISTÓN DE LA BOMBA HÍDRÁULICA HİD.POMPA PİSTON YAYI	
John Deere MTS 26689	AR39041SET	HYD.PUMP PISTON SPRING (SET OF 8) RESORTE DE PISTÓN LA BOMBA HÍDRÁULICA (JUEGO DE 8) HİD.POMPA PİSTON YAYI TK.(8 ad.)	
John Deere MTS 0060	AL71019 AL68384	HYDRAULIC PUMP CONTROL VALVE KIT VALVULA DE PRESIÓN PARA BOMBA HÍDRÁULICA HİD.POMPA BASINÇ AYAR TK.	
John Deere MTS 0039	R38041 R72936	HYD.PUMP VALVE SEAT INSERT ASIENTO DE VÁLVULA DE LA BOMBA HÍDRÁULICA HİD.POMPA TAZYİK VALF KARŞILIĞI	
John Deere MTS 0038	R40756 R68384	HYDRAULIC PUMP CONTROL VALVE VÁLVULA DE BOMBA HÍDRÁULICA HİD.POMPA TAZYİK VALFI	

Replacement Tractor Parts
Piezas de Repuesto del Tractor
Traktör Yedek Parçaları

MTSCO Ref.	Part Numbers Números de Pieza Orijinal Parça No.	Description Descripción Ürün Tanımı	Photo Fotografía Fotoğraf
John Deere MTS 0048	R68383	HYDRAULIC PUMP VALVE GUIDE GUÍA DE LA VÁLVULA DE LA BOMBA HÍDRÁULICA HİD.POMPA TAZYİK VALF PİMİ	
John Deere MTS 0045	R39240 R38049	HYDRAULIC PUMP GUIDE SPRING RESORTE DE GUÍA DE LA BOMBA HÍDRÁULICA HİD.POMPA TAZYİK YAYI	
John Deere MTS 0311	AR89073	HYDRAULIC PUMP VALVE ADJUSTER w/O'ring AJUSTE VÁLVULA BOMBA HÍDRÁULICA CON ANILLO TÓRICO HİD.POMPA KONTROL SOMUNU O'RING İLE	
John Deere MTS 0055	R39112	HYD.PUMP VALVE FITTING w/O'Ring LA TAPA VÁLVULA BOMBA HÍDRÁULICA CON ANILLO TÓRICO HİD.POMPA VALF TAPASI O'RING İLE	
John Deere MTS 0415	AR101238	HYDRAULIC PUMP PISTON SHIELD ESCUDO DEL PISTÓN DE LA BOMBA HÍDRÁULICA HİD.POMPA TAPA TEFLONU	

MTSCO Ref.	Part Numbers Números de Pieza Orijinal Parça No.	Description Descripción Ürün Tanımı	Photo Fotografía Fotoğraf
John Deere MTS 0430	AL71020	HYDRAULIC PUMP FILTER ELEMENT REP.KIT JUEGO DE PIEZAS FILTRO DE BOMBA HÍDRÁULICA HÍD.POMPA FİLTRE TM.TK.	
John Deere MTS 0375	R68381	HYDRAULIC PUMP FILTER ELEMENT FILTRO DE BOMBA HÍDRÁULICA HÍD.POMPA FİLTRESİ	
John Deere MTS 0376	R68382	HYD.PUMP FILTER ELEMENT PACKING CARTUCHO DE FILTRO DE BOMBA HÍDRÁULICA HÍD.POMPA FİLTRE LASTIĞI	
John Deere MTS 0056	R34360	HYDRAULIC PUMP SUPPORT SCREW TORNILLO PARA GOMA ABRAZADERA TRANSMISIÓN BOMBA HÍDRÁULICA HÍD.POMPA KAPLİN CIVATASI	
John Deere MTS 0334	R78293	HYDRAULIC PUMP VALVE FITTING BOMBA HÍDRÁULICA VÁLVULA DE ENTRADA PLUG B.HÍD.POM.VALFİ TAPASI	

Replacement Tractor Parts

Piezas de Repuesto del Tractor

Traktör Yedek Parçaları

MTSCO Ref.	Part Numbers Números de Pieza Orijinal Parça No.	Description Descripción Ürün Tanımı	Photo Fotografía Fotoğraf
John Deere MTS 0072	AR53301	HYDRAULIC PUMP VALVE, INLET VÁLVULA DE LA BOMBA HIDRÁULICA B.HÍD.POMPA VALFİ KOMPLE 50cm ³	
John Deere MTS 0333	R45438	HYDRAULIC PUMP FITTING 50cm ³ BOMBA HIDRÁULICA VÁLVULA DE ENTRADA PLUG 50cm ³ B.HÍD.POMPA PİSTON TAPASI 50cm ³	
John Deere MTS 0436	AR101236	HYDRAULIC PUMP PISTON SHIELD 40-50cm ³ ESCUDO DEL PISTÓN DE LA BOMBA HIDRÁULICA 40-50cm ³ B.HÍD.POMPA TAPA TEFLONU 40-50cm ³	
John Deere MTS 0073	R27150	HYDRAULIC PUMP PISTON 50cm ³ ÉMBOLO / PISTÓN DE BOMBA HIDRÁULICA 50cm ³ B.HÍD.POM.PİSTONU 50cm ³	
John Deere MTS 0370	R62372 AR76762	HYD.PUMP PISTON SPRING 50cm ³ RESORTE DE PISTÓN DE LA BOMBA HIDRÁULICA 50cm ³ B.HÍD.POMPA PİSTON YAYI 50cm ³	





Replacement Tractor Parts
Piezas de Repuesto del Tractor
Traktör Yedek Parçaları

MTSCO Ref.	Part Numbers Números de Pieza Orijinal Parça No.	Description Descripción Ürün Tanımı	Photo Fotografía Fotoğraf
John Deere MTS 0070	R79152	HYD.PUMP CRANKSHAFT 50cm3 EJE ESTRIADO BOMBA HIDRÁULICA 50 cm3 B.HİD.POM. KRANK MİLİ 50cm3	
John Deere MTS 0471	R77611	HYDRAULIC PUMP CRANKSHAFT O'RING ANILLO DE GOMA CIGÜEÑAL DE LA BOMBA HIDRÁULICA B.HİD.POM.KRANK MİLİ KANAL O'RINGİ	
John Deere MTS 0335	R27145	HYDRAULIC PUMP C.SHAFT NEEDLE ROLLER (36PCS) UNA AGUJA DE BOMBA HIDRÁULICA (36 UNID.) B.HİD.POM.KRANK MİLİ MASURA (36AD.TİP)	
John Deere MTS 0336	R45422 R116712	HYDRAULIC PUMP C.SHAFT NEEDLE ROLLER (25PCS) UNA AGUJA DE BOMBA HIDRÁULICA (25 UNID.) B.HİD.POM.KRANK MİLİ MASURA (25AD.TİP)	
John Deere MTS 0427	JD8192+JD8223	HYD.PUMP C.SHAFT BEARING SET RODAMIENTO CONO + PISTA EXTERIOR DE LA BOMBA HIDRÁULICA B.HİD.POM. KONİK RULMAN TAKIMI	

Replacement Tractor Parts

Piezas de Repuesto del Tractor

Traktör Yedek Parçaları



MTSCO Ref.	Part Numbers Números de Pieza Orijinal Parça No.	Description Descripción Ürün Tanımı	Photo Fotografía Fotoğraf
John Deere MTS 0074	JD8192	HYD.PUMP C.SHAFT BEARING CONE 50cm3 RODAMIENTO CONO DE LA BOMBA HÍDRÁULICA 50cm3 B.HÍD.POM.RULMANI 50cm3	
John Deere MTS 0075	JD8223	HYDRAULIC PUMP C.SHAFT BEARING CUP 50cm3 PISTA EXTERIOR DE RODAMIENTO DE BOMBA HÍDRÁULICA 50cm3 B.HÍD.POM. RULMAN KONİK 50cm3	
John Deere MTS 0077	R80558 R72506	HYD.PUMP C.SHAFT BEARING RACE 50cm3 PISTA DE AGUJAS DE BOMBA HÍDRÁULICA 50cm3 B.HÍD.POM. KRANK BURCU 50cm3	
John Deere MTS 0332	R72507	HYD.PUMP BRNG.RACE THRUST WASHER ARANDELA DE EMPUJE DE CIGÜEÑAL DE LA BOMBA HÍDRÁULICA B.HÍD.POM. KRANK BURCU TEFLONU	
John Deere MTS 0076	R79151	HYD.PUMP C.SHAFT LOCK WASHER 50cm3 ARANDELA DE SEGURIDAD DEL EJE DE LA BOMBA HÍDRÁULICA 50cm3 B.HÍD.POM. KRANK PULU 50cm3	

Replacement Tractor Parts
Piezas de Repuesto del Tractor
Traktör Yedek Parçaları

MTSCO Ref.	Part Numbers Números de Pieza Orijinal Parça No.	Description Descripción Ürün Tanımı	Photo Fotografía Fotoğraf
John Deere MTS 0078	R85557	HYD.PUMP C.SHAFT WASHER 50cm3 ARANDELA DEL EJE DE LA BOMBA HÍDRÁULICA 50cm3 B.HÍD.POM. ŞİM PULU 50cm3	
John Deere MTS 0391	R26137	HYD.PUMP SNAP RING ANILLO DE RETENCIÓN CON AGUJEROS DE BOMBA HÍDRÁULICA B.HÍD.POMPA GÖVDE SEKMANI	
John Deere MTS 0071	R34348 R27486	HYD.PUMP CRANKSHAFT 49cm3 EJE ESTRIADO BOMBA HÍDRÁULICA 49cm3 B.HÍD.POM. KRANK MİLİ 49cm3	
John Deere MTS 0084	R45874 R27146	HYD.PUMP C.SHAFT BEARING RACE 49cm3 PISTA EXTERIOR DE RODAMIENTO DE BOMBA HÍDRÁULICA 49cm3 B.HÍD.POM. BURCU 49cm3	
John Deere MTS 0390	AR101237	HYDRAULIC PUMP PLUG SHIELD 65 cm3 ESCUDO DEL PISTÓN DE LA BOMBA HIDRÁULICA 65 cm3 B.HÍD.POMPA TAPA TEFLONU 65cm3	

MTSCO Ref.	Part Numbers Números de Pieza Orijinal Parça No.	Description Descripción Ürün Tanımı	Photo Fotografía Fotoğraf
John Deere MTS 0085	R70976 R51827	HYDRAULIC PUMP PISTON 65cm ³ ÉMBOLO / PISTÓN DE BOMBA HÍDRÁULICA B.HÍD.POM.PİSTONU 65cm ³	
John Deere MTS 0374	AR96408	HYD.PUMP PISTON SPRING SET 65cm ³ JUEGO DE RESORTE PISTÓN DE BOMBA HÍDRÁULICA 65cm ³ B.HÍD.POM.PİSTON YAYI İÇ/DIŞ 65cm ³	
John Deere MTS 0064	R79154	HYDRAULIC PUMP CRANKSHAFT 65cm ³ FLECHA O CIGÜEÑAL PARA BOMBA HÍDRÁULICA 65cm ³ B.HÍD.POM.KRANK MİLİ KANALLI 65cm ³	
John Deere MTS 0326	R79156	HYDRAULIC PUMP CRANKSHAFT 65cm ³ FLECHA O CIGÜEÑAL PARA BOMBA HÍDRÁULICA 65cm ³ B.HÍD.POM. KRANK MİLİ 65cm ³	
John Deere MTS 0404	AR90378	HYD.PUMP REAR COVER PLUG 65cm ³ TAPÓN MACHO CILÍNDRICO CUBIERTA BOMBA HÍDRÁULICA 65cm ³ B.HÍD.POM.KAPAK YAN TAPA SETİ 65cm ³	

MTSCO Ref.	Part Numbers Números de Pieza Orijinal Parça No.	Description Descripción Ürün Tanımı	Photo Fotografía Fotoğraf
John Deere MTS 0330	R75564	HYDRAULIC PUMP VALVE PIN PASADOR DE LA VÁLVULA BOMBA HÍDRÁULICA B.HÍD.POM. ARKA KAPAK PİMİ	
John Deere MTS 0079	R70867	HYDRAULIC PUMP VALVE VÁLVULA DE LA BOMBA HÍDRÁULICA B.HÍD.POM.PİSTON VALFİ	
John Deere MTS 0349	R70868	HYDRAULIC PUMP VALVE SPRING RESORTE DE VÁLVULA DE BOMBA HÍDRÁULICA B.HÍD.POM.PİSTON VALF YAYI KÜÇÜK	
John Deere MTS 0080	AR52254	HYD.PUMP SET SCREW + NUT 14H1021 JUEGO DE BOMBA HÍDRÁULICA TORNILLO + TUERCA 14 H 1021 B.HÍD.POM.ARKA KAPAK SETLİ VİDA	
John Deere MTS 0082	RE10712 R70559	HYDRAULIC PUMP CONTROL VALVE VÁLVULA DE BOMBA HÍDRÁULICA B.HÍD.POM. KONTROL VALFİ	

MTSCO Ref.	Part Numbers Números de Pieza Orijinal Parça No.	Description Descripción Ürün Tanımı	Photo Fotografía Fotoğraf
John Deere MTS 0081	R71321	HYDRAULIC PUMP VALVE GUIDE GUÍA DE VÁLVULA DE LA BOMBA HÍDRÁULICA B.HÍD.POM. PISTON VALF KLAVUZU	
John Deere MTS 0350	R31781	HYD.PUMP VALVE GUIDE SPRING RESORTE GUÍA DE VÁLVULA DE BOMBA HIDRÁULICA B.HÍD.POM. PISTON VALF YAYI	
John Deere MTS 0083	RE13271	HYD.PUMP FIELD INSTALLATION KIT JUEGO DE INSTALACIÓN DE CAMPO DE LA BOMBA HIDRÁULICA B.HÍD.POM. SOMUNLU KON.VALFI	
John Deere MTS 0322	R79267	HYDRAULIC PUMP PLUG TAPÓN DE LA BOMBA HIDRÁULICA B.HÍD.POM. BASINÇ REKOR TAPASI	
John Deere MTS 0331	R79266	HYDRAULIC PUMP SCREW TORNILLO DE LA BOMBA HIDRÁULICA B.HÍD.POM.ARKA KPK.AYAR CIVATASI	

MTSCO Ref.	Part Numbers Números de Pieza Orijinal Parça No.	Description Descripción Ürün Tanımı	Photo Fotografía Fotoğraf
John Deere MTS 0442	R79150	HYD.PUMP CRANKSHAFT 40cm3 FLECHA O CIGÜEÑAL PARA BOMBA HIDRÁULICA 40cm3 B.HÍD.POM. KRANK MİLİ 40cm3	
John Deere MTS 0069	R39843	HYD.PUMP CRANKSHAFT 40cm3 FLECHA O CIGÜEÑAL PARA BOMBA HIDRÁULICA 40cm3 B.HÍD.POM. KRANK MİLİ 40cm3	
John Deere MTS 0124	R60732	HYDRAULIC PUMP C.SHAFT WASHER ARANDELA EMPUJE DEL EJE DE LA BOMBA HIDRÁULICA B.HÍD.POM. KRANK PULU DIŞ 40cm3	
John Deere MTS 0129	R34349	HYDRAULIC PUMP C.SHAFT WASHER 40cm3 ARANDELA DEL EJE DE LA BOMBA HIDRÁULICA 40cm3 B.HÍD.POM. KRANK PULU İÇ 40cm3	
John Deere MTS 0065	R70351 R27172	HYDRAULIC PUMP VALVE SET 40cm3 JUEGO DE VÁLVULAS DE FLUJO LA BOMBA HIDRÁULICA 40cm3 B.HÍD.POM. KNTRL.VALFİ 40cm3	

MTSCO Ref.	Part Numbers Números de Pieza Orijinal Parça No.	Description Descripción Ürün Tanımı	Photo Fotografía Fotoğraf
John Deere MTS 0119	R27173	HYDRAULIC PUMP FILTER ELEMENT 40cm3 FILTRO DE BOMBA HÍDRÁULICA 40cm3 B.HÍD.POM. FİLTRESİ 40cm3	
John Deere MTS 0377	R27174	HYDRAULIC PUMP FILTER PACKING 40cm3 SELLO DE EMBALAJE DE FILTRO DE BOMBA HÍDRÁULICA 40cm3 B.HÍD.POM. FİLTRE LASTİĞİ 40cm3	
John Deere MTS 0345	R27159	HYD.PUMP FILTER ELEMENT SPRING 40cm3 RESORTE ELEMENTO DE BOMBA HIDRÁULICA 40cm3 B.HÍD.POM. FİLTRE YAYI 40cm3	
John Deere MTS 0346	R27167	HYDRAULIC PUMP SPRING GUIDE 40cm3 GUÍA DE RESORTE DE BOMBA HIDRÁULICA 40cm3 B.HÍD.POM.FİLTRE YAY ŞAPKASI 40cm3	
John Deere MTS 0347	AR26646	HYDRAULIC PUMP PLUG 40cm3 TAPÓN DE BOMBA HIDRÁULICA 40cm3 B.HÍD.POM. FİLTRE PİMLİ TAPA 40cm3	

Replacement Tractor Parts

Piezas de Repuesto del Tractor

Traktör Yedek Parçaları

MTSCO Ref.	Part Numbers Números de Pieza Orijinal Parça No.	Description Descripción Ürün Tanımı	Photo Fotografía Fotoğraf
John Deere MTS 0348	AR51745 AR26761	HYDRAULIC PUMP PLUG 40cm3 TAPÓN DE BOMBA HIDRÁULICA 40cm3 B.HİD.POM. PİMLİ TAPA 40cm3	
John Deere MTS 0365	R35827	HYDRAULIC PUMP WASHER 40cm3 ARANDELA DE BOMBA HIDRÁULICA 40cm3 B.HİD.POM. KAUÇUKLU PUL 40cm3	
John Deere MTS 0126	RE28790	HYDRAULIC PUMP OIL SEAL RETÉN DE ACEITE DE LA BOMBA HIDRÁULICA B.HİDROLİK POMPA KEÇESİ	
John Deere MTS 0087	RE29103+RE28790 AR67718+RE28790	HYDRAULIC PUMP SEAL KIT incl. Oil Seal KIT DE SELLO DE LA BOMBA HIDRÁULICA CON RETÉN DE ACEITE B.HİD.POM.O'RING TM.TK. KEÇE DAHİL	
John Deere MTS 0088	RE29107+RE28790 AR96321+RE28790	HYDRAULIC PUMP SEAL KIT incl. Oil Seal KIT DE SELLO DE LA BOMBA HIDRÁULICA CON RETÉN DE ACEITE B.HİD.POM.O'RING TM.TK. KEÇE DAHİL	

MTSCO Ref.	Part Numbers Números de Pieza Orijinal Parça No.	Description Descripción Ürün Tanımı	Photo Fotografía Fotoğraf
John Deere MTS 0089	RE29109+RE28790 AR96323+RE28790	HYDRAULIC PUMP SEAL KIT incl. Oil Seal KIT DE SELLO DE LA BOMBA HIDRÁULICA CON RETÉN DE ACEITE B.HİD.POM.O'RING TM.TK. KEÇE DAHİL	
John Deere MTS 26301	RE28790KIT R39729KIT R56753KIT	HYD.PUMP SEAL KIT, for 40cm3 pumps KIT DE SELLO DE LA BOMBA HIDRÁULICA CON RETÉN DE ACEITE 40cm3 bombas BÜYÜK HİD.POMPA KEÇE TM.TK. 40cm3	
John Deere MTS 26302	RE28790KIT R39729KIT R56753KIT R77611KIT	HYD.PUMP SEAL KIT, for 50-65cm3 pumps KIT DE SELLO DE LA BOMBA HIDRÁULICA CON RETÉN DE ACEITE 50-65cm3 bombas B.HİD.POMPA KEÇE TM.TK. 50-65cm3	
John Deere MTS 0445	R39729	HYDRAULIC PUMP O'RING PACKING ANILLO DE GOMA DE LA BOMBA HIDRÁULICA EMBALAJE B.HİD.POM.BOĞAZ YONCA	
John Deere MTS 8530	AL158423	HYDRAULIC PUMP REGULATOR KIT REGULADOR DE BOMBA HIDRÁULICA HİDROLİK POMPA BASINÇ VALF TK.	



Replacement Tractor Parts



Piezas de Repuesto del Tractor

Traktör Yedek Parçaları

MTSCO Ref.	Part Numbers Números de Pieza Orijinal Parça No.	Description Descripción Ürün Tanımı	Photo Fotografía Fotoğraf
John Deere MTS 26199	L201123	HYDRAULIC PUMP ADAPTER FITTING BRIDA DE FIJACIÓN BOMBA HÍDRÁULICA HÍDROLİK POMPA ADAPTÖR FLANŞI	
John Deere MTS 26200	L115460	HYDRAULIC PUMP ADAPTER FITTING ADAPTADOR DE BOMBA HIDRÁULICA HÍDROLİK POMPA FLANŞI	
John Deere MTS 26203	L115460KIT	HYD.PUMP ADAPTER FITTING KIT KIT DE ADAPTADOR DE BOMBA HIDRÁULICA HÍDROLİK POMPA ADAPTÖR FLANŞ TK.	
John Deere MTS 0321	AR86535 AR45647 AR52629 AR56120 AR78396	HYD.SELECTIVE CONTROL VALVE VÁLVULA DE CONTROL BOMBA HÍDRÁULICA HÍDROLİK ARKA SELONOİD VALFİ	
John Deere MTS 0105	R54969	ROCKSHAFT CYLINDER VALVE SPOOL AGUJA VÁLVULA DEL SISTEMA DE ELEVACIÓN HÍDROLİK ROKŞAFT VALFİ	

Replacement Tractor Parts
Piezas de Repuesto del Tractor
Traktör Yedek Parçaları

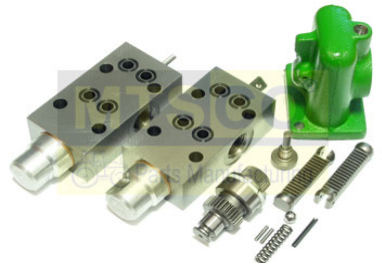
MTSCO Ref.	Part Numbers Números de Pieza Orijinal Parça No.	Description Descripción Ürün Tanımı	Photo Fotografía Fotoğraf
John Deere MTS 0106	T28538	ROCKSHAFT CYLINDER VALVE SPOOL SLEEVE ASIENTO DE LA VÁLVULA DEL SISTEMA DE ELEVACIÓN HİDROLİK ROKŞAFT VALF YUVASI	
John Deere MTS 0068	AL3459X1 AL34595X1	ONE SINGLE-ACTING SELECTIVE CONTROL VALVE w/lever UNA VÁLVULA DE CONTROL SELECTIVO DE ACCIÓN ÚNICA con palanca DAMPER VALFİ TEK ÇIKIŞLI KOLLU	
John Deere MTS 0366	AL34595X2	ONE DOUBLE-ACTING SELECTIVE CONTROL VALVE w/lever UNA VÁLVULA DE CONTROL SELECTIVO DE DOBLE ACCIÓN w/palanca DAMPER VALFİ İKİ ÇIKIŞLI KOLLU	
John Deere MTS 0393	AL34595x4	TWO DOUBLE-ACTING SELECTIVE CONTROL VALVES w/lever DOS VÁLVULAS DE CONTROL SELECTIVO DE DOBLE ACCIÓN con palanca DAMPER VALFİ DÖRT ÇIKIŞLI KOLLU	
John Deere MTS 0395	incl./incluye/içeriği: AT31874 Lever/Palanca/Kol R54275 Knob/Pomo/Topuz	SELECTIVE CONTROL VALVE LEVER PALANCA DE VÁLVULA DE CONTROL SELECTIVO DAMPER VALFİ KOLU DÜZ	

MTSCO Ref.	Part Numbers Números de Pieza Orijinal Parça No.	Description Descripción Ürün Tanımı	Photo Fotografía Fotoğraf
John Deere MTS 0396	incl./incluye/içeriği: AT31875 Lever/Palanca/Kol R54275 Knob/Pomo/Topuz	SELECTIVE CONTROL VALVE LEVER, curved PALANCA DE VÁLVULA DE CONTROL SELECTIVO CURVADO DAMPER VALFİ KOLU AÇILI	
John Deere MTS 0429	AL34595KIT incl./incluye/içeriği: AL34595x2, L39172x1, T32132x2, R53218x2, T32547x1	SELECTIVE CONTROL VALVE SET JUEGO DE VÁLVULAS DE CONTROL SELECTIVO DAMPER VALFİ İKİ ÇIKIŞLI DEMONTE SET	
John Deere MTS 0428	AL34593	SELECTIVE CONTROL VALVE VÁLVULA DE CONTROL SELECTIVO DAMPER VALFİ TEK ÇIKIŞLI (KÖRLEME)	
John Deere MTS 0090	AL34595 AL26987 AL30399 AT29022	SELECTIVE CONTROL VALVE VÁLVULA DE CONTROL SELECTIVO DAMPER VALFİ TEK ÇIKIŞLI	
John Deere MTS 0397	-	SELECTIVE CONTROL VALVE REP.KIT JUEGO DE REPARACIÓN VÁLVULA DE CONTROL SELECTIVO DAMPER VALFİ TM.TK.	

Replacement Tractor Parts

Piezas de Repuesto del Tractor

Traktör Yedek Parçaları

MTSCO Ref.	Part Numbers Números de Pieza Orijinal Parça No.	Description Descripción Ürün Tanımı	Photo Fotografía Fotoğraf
John Deere MTS 0372	L39172	HYD.SYSTEM, RACK COVER w/Rep.Kit SISTEMA HIDRÁULICO, CUBIERTA DE ESTANTERÍA CON JUEGO DE REPARACIÓN KRAMİER GÖVDESİ	
John Deere MTS 0394	L62225KIT incl./incluye/içeriği: L62225, R53801, R26552, 34M7023	HYD.SYSTEM, RACK COVER Rep.Kit JUEGO DE REPARACIÓN DE SISTEMA HIDRÁULICO, CUBIERTA DE ESTANTERÍA KRAMİER GÖVDESİ TM.TK.	
John Deere MTS 0107	T32132	HYDRAULIC SYSTEM, RACK CREMALLERA MOVIMIENTOS DE VÁLVULAS CONTROL SELECTIVO KRAMİER DİŞLİ	
John Deere MTS 0373	R53218	HYD.SYSTEM, RACK NEEDLE ROLLER PASADOR CILINDRO SISTEMA HIDRÁULICA KRAMİER DİŞLİ PİMİ	
John Deere MTS 0108	T32547	HYDRAULIC SYSTEM, DRIVE SHAFT SISTEMA HIDRÁULICO, EJE DE TRANSMISIÓN HİD.SEL.KONT. KRAMİER DİŞLİ	

Replacement Tractor Parts

Piezas de Repuesto del Tractor

Traktör Yedek Parçaları

MTSCO Ref.	Part Numbers Números de Pieza Orijinal Parça No.	Description Descripción Ürün Tanımı	Photo Fotografía Fotoğraf
John Deere MTS 26102	AL37218	ROCKSHAFT CYLINDER HOUSING CARCASA DEL CILINDRO DEL EJE DE BALANCÍN HİDROLİK SİLİNDİR GÖVDESİ	
John Deere MTS 26012	L168344	ROCKSHAFT Z=12 EJE DE ROCAS Z=12 HİDROLİK FREZELİ MİL Z=12	
John Deere MTS 26013	L76099	ROCKSHAFT Z=28 EJE DE ROCAS Z=28 HİDROLİK FREZELİ MİL Z=28	
John Deere MTS 26014	L152475	ROCKSHAFT Z=31 EJE DE ROCAS Z=31 HİDROLİK FREZELİ MİL Z=31	
John Deere MTS 26015	R111550	ROCKSHAFT Z=36 EJE DE ROCAS Z=36 HİDROLİK FREZELİ MİL Z=36	





MTSCO Ref.	Part Numbers Números de Pieza Orijinal Parça No.	Description Descripción Ürün Tanımı	Photo Fotografía Fotoğraf
John Deere MTS 26039	R126709	ROCKSHAFT Z=36, w/groove EJE DE ROCAS Z=36 con ranura HİDROLİK FREZELİ MİL Z=36, KANALLI	
John Deere MTS 26029	R117816	ROCKSHAFT Z=41 EJE DE ROCAS Z=36 HİDROLİK FREZELİ MİL Z=41	
John Deere MTS 26071	R105154	HYDRAULIC LIFT ARM BRAZO ELEVADOR HIDRÁULICO HİDROLİK KALDIRMA KOLU	
John Deere MTS 26320	T22914	PUMP DRIVE SHAFT, SPLINED 121mm EJE DE TRANSMISIÓN / ACCIONAMIENTO DE BOMBA, ESTRIADO 121mm HİD.POMPA ŞAFTI KAMALI TİP 121mm	
John Deere MTS 26323	L34573	PUMP DRIVE SHAFT, SPLINED 14T, 187,20mm EJE DE TRANSMISIÓN / ACCIONAMIENTO DE BOMBA, ESTRIADO 14T, 187, 20mm HİD.POMPA ŞAFTI FREZELİ 14T, 187,20mm	

Replacement Tractor Parts

Piezas de Repuesto del Tractor

Traktör Yedek Parçaları



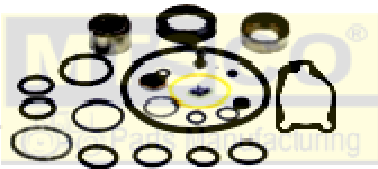

MTSCO Ref.	Part Numbers Números de Pieza Orijinal Parça No.	Description Descripción Ürün Tanımı	Photo Fotografía Fotoğraf
John Deere MTS 26324	L42188	PUMP DRIVE SHAFT, SPLINED 14T, 240mm EJE DE TRANSMISIÓN / ACCIONAMIENTO DE BOMBA, ESTRIADO 14T, 240mm HİD.POMPA ŞAFTI FREZELİ 14T, 240mm	
John Deere MTS 26325	L34571	PUMP DRIVE SHAFT, KEYED TYPE, 160mm EJE DE TRANSMISIÓN / ACCIONAMIENTO DE BOMBA, ESTRIADO 160mm HİD.POMPA ŞAFTI KAMALI TİP 160mm	
John Deere MTS 8540	AL114392	HYDRAULIC PUMP ADAPTER FITTING BRIDA DE FIJACIÓN BOMBA HÍDRÁULICA HİD.POMPA BAĞLANTI ADAPTÖRÜ	
John Deere MTS 26205	AL172261	HITCH VALVE VÁLVULA HÍDRÁULICA DISTRIBUIDOR SELLEKTÖR VALFİ	
John Deere MTS 26206	AL161388 AL166506	HITCH VALVE SPACER RODAJA HÍDRÁULICA SELLEKTÖR VALFİ	

MTSCO Ref.	Part Numbers Números de Pieza Orijinal Parça No.	Description Descripción Ürün Tanımı	Photo Fotografía Fotoğraf
John Deere MTS 26207	AL172261KIT	HITCH VALVE ASSY. RODAJA HIDRÁULICA DE ENGANCHE SELLEKTÖR VALF KOMPLESİ	
John Deere MTS 26208	AL171118	SELECTIVE CONTROL VALVE VÁLVULA DE CONTROL SELECTIVO HİDROLİK SELLEKTÖR KONTROL VALFİ	
John Deere MTS 26218	RE246372 AL78187 RE239127 AL119219	SELECTIVE CONTROL VALVE VÁLVULA DE CONTROL SELECTIVO HİDROLİK SELLEKTÖR KONTROL VALFİ	
John Deere MTS 26209	AL169780	SELECTIVE CONTROL VALVE REP.KIT JUEGO DE VÁLVULA DE CONTROL SELECTIVO HİD.SELLEKTÖR KONTROL VALFİ TM.TK	
John Deere MTS 26212	RE241164	SELECTIVE CONTROL VALVE REP.KIT JUEGO DE VÁLVULA DE CONTROL SELECTIVO HİD.SELLEKTÖR KONTROL VALFİ TM.TK	

Replacement Tractor Parts

Piezas de Repuesto del Tractor





Traktör Yedek Parçaları

MTSCO Ref.	Part Numbers Números de Pieza Orijinal Parça No.	Description Descripción Ürün Tanımı	Photo Fotografía Fotoğraf
John Deere MTS 26213	AL153258	SELECTIVE CONTROL VALVE REP.KIT JUEGO DE VÁLVULA DE CONTROL SELECTIVO HİD.SELLEKTÖR KONTROL VALFİ TM.TK	
John Deere MTS 26219	AL231707 AL206034	POWER BEYOND SPACER HOUSING CUERPO DE LA CARCASA DE VÁLVULA DE CONTROL KONTROL VALFİ BOŞLUK GÖVDESİ	
John Deere MTS 0007	AR96664 AR71383	TRANSMISSION PUMP big bearing type, w/out bearing BOMBA DE TRANSMISIÓN tipo cojinete grande, sin rodamiento ŞANZ.POMPASI BÜY. BİLYALI TİP 2030-2130	
John Deere MTS 0476	AR96664	TRANSMISSION PUMP with bearing BOMBA DE TRANSMISIÓN tipo cojinete con rodamiento ŞANZ.POMPASI BÜY. RULMANLI 2030-2130	
John Deere MTS 0485	AT26668	TRANSMISSION PUMP with bearing BOMBA DE TRANSMISIÓN tipo cojinete con rodamiento ŞANZ.POMPASI BÜYÜK RULMANLI	

Replacement Tractor Parts

Piezas de Repuesto del Tractor





Traktör Yedek Parçaları



MTSCO Ref.	Part Numbers Números de Pieza Orijinal Parça No.	Description Descripción Ürün Tanımı	Photo Fotografía Fotoğraf
John Deere MTS 0125	AR96662 AR39107 AR39053 AR39093 AR71382 R58661 AR39164 AR71393	TRANSMISSION PUMP small bearing type, w/out bearing BOMBA DE TRANSMISIÓN tipo cojinete pequeño, sin rodamiento ŞANZ.POMPASI KÜÇÜK BİLYALI TİP	
John Deere MTS 0477	AR96662	TRANSMISSION PUMP with bearing BOMBA DE TRANSMISIÓN tipo cojinete con rodamiento ŞANZ.POMPASI KÜÇÜK RULMANLI	
John Deere MTS 0008	AL41639	TRANSMISSION PUMP Gear set keyed, flange single groove BOMBA DE TRANSMISIÓN Juego de engranajes con llave, brida única ranura ŞANZ.POMPASI İNCE KAMALI	
John Deere MTS 0408	AL29878 AL41637	TRANSMISSION PUMP Gear set keyed, flange single groove BOMBA DE TRANSMISIÓN Juego de engranajes con llave, brida única ranura ŞANZ.POMPASI, İNCE KAMALI, KALIN BORULU	
John Deere MTS 0009	AL69761 AL28923 AL39355	TRANSMISSION PUMP Gear set keyed, flange single groove BOMBA DE TRANSMISIÓN Juego de engranajes con llave, brida única ranura ŞANZ.POMPASI KALIN KAMALI	

Replacement Tractor Parts

Piezas de Repuesto del Tractor

Traktör Yedek Parçaları

MTSCO Ref.	Part Numbers Números de Pieza Orijinal Parça No.	Description Descripción Ürün Tanımı	Photo Fotografía Fotoğraf
John Deere MTS 0067	AL120106	TRANSMISSION PUMP Gear set keyed, flange double groove BOMBA DE TRANSMISIÓN Juego de engranajes con llave, brida doble ranura ŞANZ.POMPASI, KALIN KAMALI, ÇİFT KANAL	
John Deere MTS 0010	AL68094	TRANSMISSION PUMP Gear set keyed, flange single groove BOMBA DE TRANSMISIÓN Juego de engranajes con llave, brida única ranura ŞANZ.POMPASI, FREZELİ	
John Deere MTS 0407	AL120107 AL69762 AL57680	TRANSMISSION PUMP Gear set keyed BOMBA DE TRANSMISIÓN Juego de engranajes ŞANZ.POMPASI, KALIN KAMALI, BORUSUZ	 Rear View Rückansicht Front View Vorderansicht
John Deere MTS 0417	AL68091	TRANSMISSION PUMP Gear set keyed BOMBA DE TRANSMISIÓN Juego de engranajes ŞANZ.POMPASI, FREZELİ, BORUSUZ	 Rear View Rückansicht Front View Vorderansicht
John Deere MTS 22116	AL155632	TRANSMISSION PUMP BOMBA DE TRANSMISIÓN ŞANZIMAN POMPASI	

MTSCO Ref.	Part Numbers Números de Pieza Orijinal Parça No.	Description Descripción Ürün Tanımı	Photo Fotografía Fotoğraf
John Deere MTS 0491	AR69659	TRANS.PUMP APAPTER FITTING TAPA DE LA BOMBA DE ACEITE DE LA CAJA DE TRANSMISIÓN ŞANZ.POMPASI KAPAĞI	
John Deere MTS 22128	AR71395 CASTING NO.R57960	TRANS.PUMP APAPTER FITTING TAPA DE LA BOMBA DE ACEITE DE LA CAJA DE TRANSMISIÓN ŞANZ.POMPASI KAPAĞI	
John Deere MTS 22118	JD8720	TRANSMISSION PUMP BEARING 80mm COJINETE DE BOMBA DE TRANSMISIÓN 80mm ŞANZ.POMPASI RULMANI 80mm	
John Deere MTS 22119	JD7943	TRANSMISSION PUMP BEARING 90mm COJINETE DE BOMBA DE TRANSMISIÓN 90mm ŞANZ.POMPASI RULMANI 90mm	
John Deere MTS 0313	AR39164	TRANSMISSION PUMP GEAR KIT Z=16/32 JUEGO DE ENGRANAJES BOMBA TRANSMISIÓN Z=16/32 ŞANZ.POM.DİŞLİ TK.16/32 BORUSUZ	

Replacement Tractor Parts

Piezas de Repuesto del Tractor

Traktör Yedek Parçaları





MTSCO Ref.	Part Numbers Números de Pieza Orijinal Parça No.	Description Descripción Ürün Tanımı	Photo Fotografía Fotoğraf
John Deere MTS 0066	AR71393	TRANSMISSION PUMP GEAR KIT Z=13/26 JUEGO DE ENGRANAJES BOMBA TRANSMISIÓN Z=13/26 ŞANZ.POM.DİŞLİ TK.13/26 BORUSUZ	
John Deere MTS 0011	AL68435 Thickness/Espesor/Kalınlık 10,6mm +/- 0,02mm	TRANSMISSION PUMP GEAR SET keyed JUEGO DE ENGRANAJES BOMBA TRANSMISIÓN con llave ŞANZ.POMPASI DİŞLİ TK. 10,6mm	
John Deere MTS 0123	AL119948 AL39778 Thickness/Espesor/Kalınlık 8,4mm +/- 0,02mm	TRANSMISSION PUMP GEAR SET keyed JUEGO DE ENGRANAJES BOMBA TRANSMISIÓN con llave ŞANZ.POMPASI DİŞLİ TK. 8,4mm	
John Deere MTS 0012	AL119950 AL69638 AL71294	TRANSMISSION PUMP GEAR SET splined JUEGO DE ENGRANAJES DE LA BOMBA DE TRANSMISIÓN estriado ŞANZ.POMPASI DİŞLİ TK. FREZELİ 3155	
John Deere MTS 0482	AL68435A	TRANSMISSION PUMP GEAR SET keyed 13,5mm JUEGO DE ENGRANAJES BOMBA TRANSMISIÓN con llave 13,5mm ŞANZ.POMPASI DİŞLİ TK. 13,5mm	

MTSCO Ref.	Part Numbers Números de Pieza Orijinal Parça No.	Description Descripción Ürün Tanımı	Photo Fotografía Fotoğraf
John Deere MTS 0483	AL68435B	TRANSMISSION PUMP GEAR SET keyed 21,2mm JUEGO DE ENGRANAJES BOMBA TRANSMISIÓN con llave 21,2mm ŞANZ.POMPASI DİŞLİ TK. 21,2mm	
John Deere MTS 0484	AT26669+T28697	TRANSMISSION PUMP GEAR SET keyed 16/32 (17,95 mm) JUEGO DE ENGRANAJES BOMBA TRANSMISIÓN con llave 16/32 (17,95 mm) ŞANZ.POMPASI DİŞLİ TK. 17,95mm	
John Deere MTS 22120	R108927	TRANS.PUMP GEAR OUTER 12,20mm ENGRANAJE DE BOMBA DE TRANSMISIÓN EXTERIOR 12,20mm ŞANZ.POMPASI DİŞLİSİ DIŞ 12,20mm	
John Deere MTS 22121	R108925	TRANS.PUMP GEAR INNER 12,20mm ENGRANAJE DE BOMBA DE TRANSMISIÓN INTERIOR 12,20mm ŞANZ.POMPASI DİŞLİSİ İÇ 12,20mm	
John Deere MTS 22134	R108927+R108925	TRANS.PUMP GEAR SET 12,20mm JUEGO DE ENGRANAJES BOMBA TRANSMISIÓN 12,20mm ŞANZ.POMPASI DİŞLİSİ TK.12,20mm	

Replacement Tractor Parts

Piezas de Repuesto del Tractor





Traktör Yedek Parçaları

MTSCO Ref.	Part Numbers Números de Pieza Orijinal Parça No.	Description Descripción Ürün Tanımı	Photo Fotografía Fotoğraf
John Deere MTS 22122	R161742	TRANS.PUMP GEAR OUTER 15,00mm ENGRANAJE DE BOMBA DE TRANSMISIÓN EXTERIOR 15,00mm ŞANZ.POMPASI DİŞLİSİ DIŞ 15,00mm	
John Deere MTS 22123	R161741	TRANS.PUMP GEAR INNER 15,00mm ENGRANAJE DE BOMBA DE TRANSMISIÓN INTERIOR 15,00 mm ŞANZ.POMPASI DİŞLİSİ İÇ 15,00mm	
John Deere MTS 22135	R161742+R161741	TRANS.PUMP GEAR SET 15,00mm JUEGO DE ENGRANAJES BOMBA TRANSMISIÓN 15,00mm ŞANZ.POMPASI DİŞLİSİ TK.15,00mm	
John Deere MTS 22124	R246016	TRANS.PUMP GEAR OUTER 17,25mm ENGRANAJE DE BOMBA DE TRANSMISIÓN EXTERIOR 17,25 mm ŞANZ.POMPASI DİŞLİSİ DIŞ 17,25mm	
John Deere MTS 22125	R246015	TRANS.PUMP GEAR INNER 17,25mm ENGRANAJE DE BOMBA DE TRANSMISIÓN INTERIOR 17,25 mm ŞANZ.POMPASI DİŞLİSİ İÇ 17,25mm	

Replacement Tractor Parts

Piezas de Repuesto del Tractor



Traktör Yedek Parçaları

MTSCO Ref.	Part Numbers Números de Pieza Orijinal Parça No.	Description Descripción Ürün Tanımı	Photo Fotografía Fotoğraf
John Deere MTS 22136	R246016+R246015	TRANS.PUMP GEAR SET 17,25mm JUEGO DE ENGRANAJES BOMBA TRANSMISIÓN 17,25mm ŞANZ.POMPASI DİŞLİSİ TK.17,25mm	
John Deere MTS 22126	R108928	TRANS.PUMP GEAR OUTER 19,50mm ENGRANAJE DE BOMBA DE TRANSMISIÓN EXTERIOR 19,50mm ŞANZ.POMPASI DİŞLİSİ DIŞ 19,50mm	
John Deere MTS 22127	R108926	TRANS.PUMP GEAR INNER 19,50mm ENGRANAJE DE BOMBA DE TRANSMISIÓN INTERIOR 19,50 mm ŞANZ.POMPASI DİŞLİSİ İÇ 19,50mm	
John Deere MTS 22137	R108928+R108926	TRANS.PUMP GEAR SET 19,50mm JUEGO DE ENGRANAJES BOMBA TRANSMISIÓN 19,50 mm ŞANZ.POMPASI DİŞLİSİ TK.19,50mm	
John Deere MTS 22110	R161739	TRANSMISSION PUMP HOUSING 15,00mm CARCASA DE LA BOMBA DE TRANSMISIÓN 15,00mm ŞANZIMAN POMPA GÖVDESİ 15,00mm	

Replacement Tractor Parts

Piezas de Repuesto del Tractor

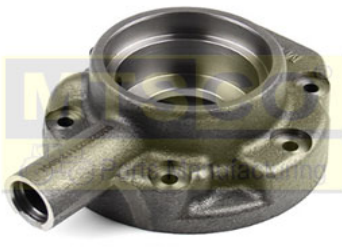
Traktör Yedek Parçaları

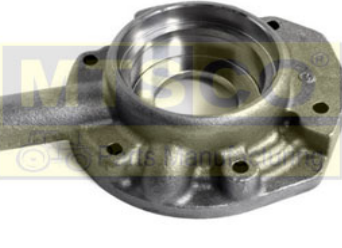
MTSCO Ref.	Part Numbers Números de Pieza Orijinal Parça No.	Description Descripción Ürün Tanımı	Photo Fotografía Fotoğraf
John Deere MTS 22111	AL81352 AL166744	TRANSMISSION PUMP HOUSING 12,20mm CARCASA DE LA BOMBA DE TRANSMISIÓN 12,20mm ŞANZIMAN POMPA GÖVDESİ 12,20mm	
John Deere MTS 22112	R246017	TRANSMISSION PUMP HOUSING 17,25mm CARCASA DE LA BOMBA DE TRANSMISIÓN 17,25mm ŞANZIMAN POMPA GÖVDESİ 17,25mm	
John Deere MTS 22113	R109001	TRANSMISSION PUMP HOUSING 19,50mm CARCASA DE LA BOMBA DE TRANSMISIÓN 19,50mm ŞANZIMAN POMPA GÖVDESİ 19,50mm	
John Deere MTS 22114	R312751	TRANSMISSION PUMP HOUSING 12,20mm CARCASA DE LA BOMBA DE TRANSMISIÓN DOBLE VÁLVULA 12,20mm ŞANZ.POMPA GÖVDESİ 12,20mm, ÇİFT VALFLİ	
John Deere MTS 22115	R130488	TRANSMISSION PUMP HOUSING 12,20mm CARCASA DE LA BOMBA DE TRANSMISIÓN 12,20mm ŞANZ.POMPA GÖVDESİ 12,20mm, TEK VALFLİ	

Replacement Tractor Parts

Piezas de Repuesto del Tractor

Traktör Yedek Parçaları

MTSCO Ref.	Part Numbers Números de Pieza Orijinal Parça No.	Description Descripción Ürün Tanımı	Photo Fotografía Fotoğraf
John Deere MTS 22117	RE47291	TRANSMISSION PUMP VALVE REP.KIT REPARACIÓN DE LA VÁLVULA DE BOMBA DE TRANSMISIÓN ŞANZ.POMPA VALF TM.TK	
John Deere MTS 22101	R120947	TRANSMISSION PUMP VALVE VÁLVULA DE BOMBA DE TRANSMISIÓN ŞANZIMAN POMPA VALFİ	
John Deere MTS 22129	RE162140	TRANS.PUMP INPUT SHAFT, w/bushing EJE DE ENTRADA DE LA BOMBA DE TRANSFERENCIA con buje ŞANZ.POMPA ŞAFTI BURÇ DAHİL	
John Deere MTS 22130	RE222630 RE232943 RE54871	TRANS.PUMP INPUT SHAFT, w/bushing EJE DE ENTRADA DE LA BOMBA DE TRANSFERENCIA con buje ŞANZ.POMPA ŞAFTI BURÇ DAHİL	
John Deere MTS 22132	RE222632	TRANS.PUMP INPUT SHAFT, w/bushing EJE DE ENTRADA DE LA BOMBA DE TRANSFERENCIA con buje ŞANZ.POMPA ŞAFTI BURÇ DAHİL	

Replacement Tractor Parts
Piezas de Repuesto del Tractor
Traktör Yedek Parçaları

MTSCO Ref.	Part Numbers Números de Pieza Orijinal Parça No.	Description Descripción Ürün Tanımı	Photo Fotografía Fotoğraf
John Deere MTS 22133	RE225878	TRANS.PUMP INPUT SHAFT, w/bushing EJE DE ENTRADA DE LA BOMBA DE TRANSFERENCIA con buje ŞANZ.POMPA ŞAFTI BURÇ DAHİL	
John Deere MTS 7142	AL64060	DRIVE SHAFT Z=32X14 EJE DE TRANSMISIÓN Z=32X14 SENKROMEÇ AKTARMA MİLİ Z=32X14	
John Deere MTS 7143	AL66410	DRIVE SHAFT Z=29X14 EJE DE TRANSMISIÓN Z=29X14 SENKROMEÇ AKTARMA MİLİ Z=29X14	
John Deere MTS 7152	AL39983	DRIVE SHAFT Z=29X14 EJE DE TRANSMISIÓN Z=29X14 SENKROMEÇ AKTARMA MİLİ Z=29X14	
John Deere MTS 7144	L64122	DRIVE SHAFT EJE DE TRANSMISIÓN SENKROMEÇ AKTARMA MİLİ	

MTSCO Ref.	Part Numbers Números de Pieza Orijinal Parça No.	Description Descripción Ürün Tanımı	Photo Fotografía Fotoğraf
John Deere MTS 7149	L55841	DRIVE SHAFT NUT TUERCA DEL EJE DE TRANSMISIÓN HUECO SENKROMEÇ AKTARMA MİLİ SOMUNU	
John Deere MTS 0013	R53817	GEARSHIFT LEVER PALANCA DE CAMBIO VİTES KOLU MİLİ	
John Deere MTS 7148	L33050	SYNCHRONIZER FORK HORQUILLA DE CAJA DE CAMBIOS VİTES ÇATALI	
John Deere MTS 7339	L36538	SYNCHRONIZER FORK HORQUILLA DE CAJA DE CAMBIOS VİTES ÇATALI	
John Deere MTS 0113	L28712 L38806	PTO SHAFT Z=21 (For Standard PTO 540) EJE TOMA DE FUERZA Z=21 (Para la toma de fuerza estándar 540) KUYRUK MİLİ Z=21 (Standart 540 kuyruk mili için)	

Replacement Tractor Parts

Piezas de Repuesto del Tractor

Traktör Yedek Parçaları

MTSCO Ref.	Part Numbers Números de Pieza Orijinal Parça No.	Description Descripción Ürün Tanımı	Photo Fotografía Fotoğraf
John Deere MTS 7709	R238315	PTO SHAFT EJE TOMA DE FUERZA KUYRUK MİLİ	
John Deere MTS 7710	L173282 L110178 L156976 L151598	PTO SHAFT Z=21X6 EJE TOMA DE FUERZA Z=21X6 KUYRUK MİLİ Z=21X6	
John Deere MTS 7717	L173282-M L110178-M L156976-M L151598-M	PTO SHAFT Z=21X6, 1 3/4" EJE TOMA DE FUERZA Z=21X6, 1 3/4" KUYRUK MİLİ Z=21X6, 1 3/4"	
John Deere MTS 7711	L173283	PTO SHAFT 234mm EJE TOMA DE FUERZA 234mm KUYRUK MİLİ 234mm	
John Deere MTS 7712	L173284	PTO SHAFT Z=14 EJE TOMA DE FUERZA Z=14 KUYRUK MİLİ Z=14	

MTSCO Ref.	Part Numbers Números de Pieza Orijinal Parça No.	Description Descripción Ürün Tanımı	Photo Fotografía Fotoğraf
John Deere MTS 7714	L173241	PTO SHAFT Z=14 EJE TOMA DE FUERZA Z=14 KUYRUK MİLİ Z=14	
John Deere MTS 7713	L173282R	PTO SHAFT Z=33 EJE TOMA DE FUERZA Z=33 KUYRUK MİLİ Z=33	
John Deere MTS 7763	R562721	PTO SHAFT Z=33 EJE TOMA DE FUERZA Z=33 KUYRUK MİLİ Z=33	
John Deere MTS 7764	R33342	PTO SHAFT Z=21 / 1000 RPM EJE TOMA DE FUERZA Z=21 / 1000 KUYRUK MİLİ Z=21 / 1000 RPM	
John Deere MTS 7765	AR41753	PTO SHAFT Z=6 / 540 RPM EJE TOMA DE FUERZA Z=6 / 540 RPM KUYRUK MİLİ Z=6 / 540 RPM	

Replacement Tractor Parts
Piezas de Repuesto del Tractor
Traktör Yedek Parçaları

MTSCO Ref.	Part Numbers Números de Pieza Orijinal Parça No.	Description Descripción Ürün Tanımı	Photo Fotografía Fotoğraf
John Deere MTS 7726	YZ91593	PTO OUTPUT SHAFT EJE DE SALIDA DE LA TOMA DE FUERZA PTO AKTARMA MİLİ	
John Deere MTS 7727	R230861	PTO OUTPUT SHAFT EJE DE SALIDA DE LA TOMA DE FUERZA PTO AKTARMA MİLİ	
John Deere MTS 7728	L202815	PTO OUTPUT SHAFT EJE DE SALIDA DE LA TOMA DE FUERZA PTO AKTARMA MİLİ	
John Deere MTS 7729	R129768	PTO OUTPUT SHAFT 305,0mm EJE DE SALIDA DE LA TOMA DE FUERZA 305,0mm PTO AKTARMA MİLİ 305,0mm	
John Deere MTS 7730	L101903	PTO OUTPUT SHAFT 267,5mm EJE DE SALIDA DE LA TOMA DE FUERZA 267,5mm PTO AKTARMA MİLİ 267,5mm	

Replacement Tractor Parts

Piezas de Repuesto del Tractor

Traktör Yedek Parçaları

MTSCO Ref.	Part Numbers Números de Pieza Orijinal Parça No.	Description Descripción Ürün Tanımı	Photo Fotografía Fotoğraf
John Deere MTS 7731	R128425	PTO OUTPUT SHAFT 305,0mm EJE DE SALIDA DE LA TOMA DE FUERZA 305,0mm PTO AKTARMA MİLİ 305,0mm	
John Deere MTS 7732	L102682	PTO OUTPUT SHAFT EJE DE SALIDA DE LA TOMA DE FUERZA PTO AKTARMA MİLİ	
John Deere MTS 7733	R231766	PTO OUTPUT SHAFT 305,0mm EJE DE SALIDA DE LA TOMA DE FUERZA 305,0mm PTO AKTARMA MİLİ 305,0mm	
John Deere MTS 7734	L173244 L155595	PTO OUTPUT SHAFT EJE DE SALIDA DE LA TOMA DE FUERZA PTO AKTARMA MİLİ	
John Deere MTS 7735	L202816 L155602 L173243 L151901	PTO OUTPUT SHAFT EJE DE SALIDA DE LA TOMA DE FUERZA PTO AKTARMA MİLİ	

Replacement Tractor Parts

Piezas de Repuesto del Tractor



Traktör Yedek Parçaları

MTSCO Ref.	Part Numbers Números de Pieza Orijinal Parça No.	Description Descripción Ürün Tanımı	Photo Fotografía Fotoğraf
John Deere MTS 7736	R230862	PTO OUTPUT SHAFT EJE DE SALIDA DE LA TOMA DE FUERZA PTO AKTARMA MİLİ	
John Deere MTS 7737	R133086	PTO OUTPUT SHAFT EJE DE SALIDA DE LA TOMA DE FUERZA PTO AKTARMA MİLİ	
John Deere MTS 7738	R234478	PTO OUTPUT SHAFT EJE DE SALIDA DE LA TOMA DE FUERZA PTO AKTARMA MİLİ	
John Deere MTS 7739	R266971	PTO OUTPUT SHAFT EJE DE SALIDA DE LA TOMA DE FUERZA PTO AKTARMA MİLİ	
John Deere MTS 7770	L78945	PTO OUTPUT SHAFT 270,0mm EJE DE SALIDA DE LA TOMA DE FUERZA 270,0mm PTO AKTARMA MİLİ 270,0mm	

Replacement Tractor Parts

Piezas de Repuesto del Tractor

Traktör Yedek Parçaları

MTSCO Ref.	Part Numbers Números de Pieza Orijinal Parça No.	Description Descripción Ürün Tanımı	Photo Fotografía Fotoğraf
John Deere MTS 0014	T38049	DIFFERENTIAL, PLANETARY PINION SHAFT EJE DEL PIÑÓN DEL DIFERENCIAL DEFRANSİYEL GÜNEŞ DİŞLİ PİMİ	
John Deere MTS 0015	L29226 T21875	DIFFERENTIAL CROSS SHAFT EJE DEL ENGRANAJE CHANFLEADO DEL DIFERENCIAL İSTAVROZ MİLİ	
John Deere MTS 0019	T30253	DIFFERENTIAL HOUSING 8 holes (rivet 1/2") CARCASA DE DIFERENCIAL 8 Agujeros (remache 1/2") İSTAVROZ YATAĞI 8 DEL.1/2" PERÇİN	
John Deere MTS 0425	T59690	DIFFERENTIAL HOUSING 8 holes (rivet 7/16") CARCASA DE DIFERENCIAL 8 Agujeros (remache 7/16") İSTAVROZ YATAĞI 8 DEL.7/16" PERÇİN	
John Deere MTS 0470	L31794	DIFFERENTIAL HOUSING 16 holes (rivet 7/16") CARCASA DE DIFERENCIAL 16 Agujeros (remache 7/16") İSTAVROZ YATAĞI 16 DEL.7/16" PERÇİN	

Replacement Tractor Parts

Piezas de Repuesto del Tractor

Traktör Yedek Parçaları

MTSCO Ref.	Part Numbers Números de Pieza Orijinal Parça No.	Description Descripción Ürün Tanımı	Photo Fotografía Fotoğraf
John Deere MTS 0020	L32573	DIFFERENTIAL HOUSING 16 holes CARCASA DE DIFERENCIAL 16 Agujeros İSTAVROZ YATAĞI 16 DEL.	
John Deere MTS 0021	L36205	DIFFERENTIAL HOUSING 16 holes CARCASA DE DIFERENCIAL 16 Agujeros İSTAVROZ YATAĞI 16 DEL.	
John Deere MTS 0016	R51500	DIFFERENTIAL HOUSING Z=12 CARCASA DE DIFERENCIAL Z=12 PATİNAJ KARPUSU Z=12	
John Deere MTS 0017	L32568	DIFFERENTIAL HOUSING Z=20 CARCASA DE DIFERENCIAL Z=20 PATİNAJ KARPUSU Z=20	
John Deere MTS 0424	L31791	DIFFERENTIAL HOUSING Z=23 CARCASA DE DIFERENCIAL Z=23 PATİNAJ KARPUSU Z=23	

MTSCO Ref.	Part Numbers Números de Pieza Orijinal Parça No.	Description Descripción Ürün Tanımı	Photo Fotografía Fotoğraf
John Deere MTS 0018	L36199	DIFFERENTIAL HOUSING Z=23 CARCASA DE DIFERENCIAL Z=23 PATİNAJ KARPUSU Z=23	
John Deere MTS 24115	AL76888	BEARING W/2 snap ring RODAMIENTO DE PLANETARIO con 2 anillos de retención ARKA AKS RULMANI, 2 SEGMANLI	
John Deere MTS 24116	L112530	BEARING SNAP RING ANILLO DE RETENCIÓN DEL RODAMIENTO ARKA AKS RULMANI SEGMANI	
John Deere MTS 0022	AL31262	STEERING GEAR ASSY. CONJUNTO DE HIDRÁULICO DIRECCIÓN HİDROLİK DİREKSİYON KOMPLE	
John Deere MTS 0478	AT26188	STEERING GEAR ASSY. REP.KIT JUEGO DE REPARACIÓN PARA CONJUNTO DE HIDRÁULICO DIRECCIÓN HİDROLİK DİREKSİYON TM.TK.	

MTSCO Ref.	Part Numbers Números de Pieza Orijinal Parça No.	Description Descripción Ürün Tanımı	Photo Fotografía Fotoğraf
John Deere MTS 0434	L34451	STEERING GEAR ASSY. O'RING ANILLO DE GOMA DEL CONJUNTO DE HÍDRÁULICO DIRECCIÓN HİDROLİK DİREKSİYON O'RING	
John Deere MTS 0310	AL31515	STEERING HOUSING CARCASA COLUMNA DE DIRECCIÓN HİD.DİREKSİYON GÖVDESİ	
John Deere MTS 0026	L29199	STEERING SHAFT EJE SIN FIN DIRECCIÓN HİD.DİREKSİYON MİLİ	
John Deere MTS 0024	AL26311	STEERING, SLEEVE ASSEMBLY lower VÁLVULA DE RETORNO 3 TALADROS HİD.DİREKSİYON ROTORU 3 DEL.	
John Deere MTS 0025	AL26312	STEERING, SLEEVE ASSEMBLY upper VÁLVULA DE RETORNO 1 TALADRO HİD.DİREKSİYON ROTORU TEK DEL.	





MTSCO Ref.	Part Numbers Números de Pieza Orijinal Parça No.	Description Descripción Ürün Tanımı	Photo Fotografía Fotoğraf
John Deere MTS 0023	T25323 AL70300	STEERING ROD PISTÓN DE DIRECCIÓN HİD.DİREKSİYON ROT PISTON YATAĞI	
John Deere MTS 0027	L35639	STEERING DRAG LINK RÓTULA / BIELA DE LA CAJA DE DIRECCIÓN HİD.DİREKSİYON KÖPEK KEMİĞİ	
John Deere MTS 0317	T21655	STEERING DRAG LINK PIN BULÓN BIELA DE LA CAJA DE DIRECCIÓN HİD.DİREKSİYON KÖPEK KEMİĞİ PİMİ	
John Deere MTS 0319	L34454	STEERING ROD GUIDE GUÍA DE LA BARRA DE DIRECCIÓN HİD.DİREKSİYON MERKEZLEME PİSTONU	
John Deere MTS 0318	T25325	STEERING PISTON PISTÓN DE DIRECCIÓN HİD.DİREKSİYON PİSTONU	

MTSCO Ref.	Part Numbers Números de Pieza Orijinal Parça No.	Description Descripción Ürün Tanımı	Photo Fotografía Fotoğraf
John Deere MTS 0323	AL31925	STEERING, PRESSURE RELIEF VALVE VÁLVULA ALIVIO DE PRESIÓN DE DIRECCIÓN HÍDRÁULICA HİD.DİREKSİYON VALFİ	
John Deere MTS 0439	AR65881 KIT incl./incluye R40072 Spring/Primavera	STEERING, PRESSURE RELIEF VALVE REP.KIT JUEGO DE REPARACIÓN VÁLVULA ALIVIO DE PRESIÓN DE DIRECCIÓN HÍDRÁULICA HİD.DİREKSİYON VALF TM.TK.	
John Deere MTS 0443	R35226	STEERING, SNAP RING ANILLO DE SEGURIDAD DE DIRECCIÓN HİDROLİK DİREKSİYON SEGMANI	
John Deere MTS 18350	T21722	STEERING SHAFT PIN BULÓN DE BIELA DE DIRECCIÓN DİREKSİYON SEKTÖR ÇATAL PİMİ	
John Deere MTS 0115	L35604 Case-IH: 323 0955 R1 Fendt: F174.300.020.0130 Deutz-Fahr: 0435 9770 Ford: 8395 3219	KNUCKLE HOUSING RH MANGUETA DELANTERA DERECHA ÖN AKS KOVANI SAĞ	

Replacement Tractor Parts

Piezas de Repuesto del Tractor

Traktör Yedek Parçaları

MTSCO Ref.	Part Numbers Números de Pieza Orijinal Parça No.	Description Descripción Ürün Tanımı	Photo Fotografía Fotoğraf
John Deere MTS 0116	L35603 Case-IH: 323 0954 R1 Fendt: F174.300.020.0140 Deutz-Fahr: 0437 2696 Ford: 8395 3218	KNUCKLE HOUSING LH MANGUETA DELANTERA IZQUIERDA ÖN AKS KOVANI SOL	
John Deere MTS 19602	L60081	KNUCKLE HOUSING LH MANGUETA DELANTERA IZQUIERDA ÖN AKS KOVANI SOL	
John Deere MTS 19603	L60082	KNUCKLE HOUSING RH MANGUETA DELANTERA DERECHA ÖN AKS KOVANI SAĞ	
John Deere MTS 19604	L61201 81413C1	KNUCKLE HOUSING LH MANGUETA DELANTERA IZQUIERDA ÖN AKS KOVANI SOL	
John Deere MTS 19605	L61202 81414C1	KNUCKLE HOUSING RH MANGUETA DELANTERA DERECHA ÖN AKS KOVANI SAĞ	





MTSCO[®]

Parts Manufacturing

Replacement Tractor Parts

Piezas de Repuesto del Tractor

Traktör Yedek Parçaları

MTSCO Ref.	Part Numbers Números de Pieza Orijinal Parça No.	Description Descripción Ürün Tanımı	Photo Fotografía Fotoğraf
John Deere MTS 19606	L41927	KNUCKLE HOUSING LH MANGUETA DELANTERA IZQUIERDA ÖN AKS KOVANI SOL	
John Deere MTS 19607	L41926	KNUCKLE HOUSING RH MANGUETA DELANTERA DERECHA ÖN AKS KOVANI SAĞ	
John Deere MTS 19612	L100233	KNUCKLE HOUSING RH MANGUETA DELANTERA DERECHA ÖN AKS KOVANI SAĞ	
John Deere MTS 19613	L100234	KNUCKLE HOUSING LH MANGUETA DELANTERA IZQUIERDA ÖN AKS KOVANI SOL	
John Deere MTS 19614	L100235 L114786	KNUCKLE HOUSING RH MANGUETA DELANTERA DERECHA ÖN AKS KOVANI SAĞ	

Original Manufacturer names, part numbers and descriptions are quoted for reference purposes ONLY.
It is NOT implied that these parts supplied by ourselves are used as original equipment.



MTSCO[®]

Parts Manufacturing

Replacement Tractor Parts

Piezas de Repuesto del Tractor

Traktör Yedek Parçaları

MTSCO Ref.	Part Numbers Números de Pieza Orijinal Parça No.	Description Descripción Ürün Tanımı	Photo Fotografía Fotoğraf
John Deere MTS 19615	L100236 L114787	KNUCKLE HOUSING LH MANGUETA DELANTERA IZQUIERDA ÖN AKS KOVANI SOL	
John Deere MTS 19616	L110473	KNUCKLE HOUSING LH MANGUETA DELANTERA IZQUIERDA ÖN AKS KOVANI SOL	
John Deere MTS 19617	L110474	KNUCKLE HOUSING RH MANGUETA DELANTERA DERECHA ÖN AKS KOVANI SAĞ	
John Deere MTS 19618	L110710	KNUCKLE HOUSING LH MANGUETA DELANTERA IZQUIERDA ÖN AKS KOVANI SOL	
John Deere MTS 19619	L110707	KNUCKLE HOUSING RH MANGUETA DELANTERA DERECHA ÖN AKS KOVANI SAĞ	

Original Manufacturer names, part numbers and descriptions are quoted for reference purposes ONLY.
It is NOT implied that these parts supplied by ourselves are used as original equipment.

Replacement Tractor Parts

Piezas de Repuesto del Tractor



Traktör Yedek Parçaları

MTSCO Ref.	Part Numbers Números de Pieza Orijinal Parça No.	Description Descripción Ürün Tanımı	Photo Fotografía Fotoğraf
John Deere MTS 19620	L157636	KNUCKLE HOUSING LH MANGUETA DELANTERA IZQUIERDA ÖN AKS KOVANI SOL	
John Deere MTS 19621	L157637	KNUCKLE HOUSING RH MANGUETA DELANTERA DERECHA ÖN AKS KOVANI SAĞ	
John Deere MTS 19622	R271410	KNUCKLE HOUSING LH MANGUETA DELANTERA IZQUIERDA ÖN AKS KOVANI SOL	
John Deere MTS 19623	R271409	KNUCKLE HOUSING RH MANGUETA DELANTERA DERECHA ÖN AKS KOVANI SAĞ	
John Deere MTS 0117	L35606	KNUCKLE HOUSING, HUB PIN (TRUNNION) TOCHO MANGUETA DEL COJINETE ÖN AKS KUTU TAPASI	

Replacement Tractor Parts

Piezas de Repuesto del Tractor

Traktör Yedek Parçaları



MTSCO Ref.	Part Numbers Números de Pieza Orijinal Parça No.	Description Descripción Ürün Tanımı	Photo Fotografía Fotoğraf
John Deere MTS 19461	R75849 3146693R1	KNUCKLE HOUSING, HUB PIN (TRUNNION) PERNO DE ENGANCHE ÖN AKS KUTU TAPASI	
John Deere MTS 19469	L35745 3147233R1	KNUCKLE HOUSING, HUB PIN (TRUNNION) PERNO DE ENGANCHE ÖN AKS KUTU TAPASI	
John Deere MTS 19464	L40036	KING PIN PIVOTE DIRECCIÓN AKS KOVAN PİMİ	
John Deere MTS 19465	L100237 T188397	KING PIN PIVOTE DIRECCIÓN CUADRADO MAZA RUEDA AKS KOVAN PİMİ	
John Deere MTS 19466	L112110	KING PIN PIVOTE DIRECCIÓN CUADRADO MAZA RUEDA AKS KOVAN PİMİ	

Replacement Tractor Parts

Piezas de Repuesto del Tractor

Traktör Yedek Parçaları

MTSCO Ref.	Part Numbers Números de Pieza Orijinal Parça No.	Description Descripción Ürün Tanımı	Photo Fotografía Fotoğraf
John Deere MTS 19482	AL162110	KING PIN PIVOTE DIRECCIÓN CUADRADO MAZA RUEDA AKS KOVAN PİMİ	
John Deere MTS 19467	L40004 81670C2	KING PIN PIVOTE SUPERIOR AKS KOVAN PİMİ	
John Deere MTS 19468	L61209 81305C1	KING PIN PIVOTE DIRECCIÓN AKS KOVAN PİMİ	
John Deere MTS 0114	AL33349 Case-IH: 1502272 C1, 3132089 R91	FRONT AXLE EJE MANGUETA ÖN AKS DÖVME	
John Deere MTS 19565	T23229	FRONT AXLE WASHER ARANDELA DİNGİL BOŞLUK PULU	

MTSCO Ref.	Part Numbers Números de Pieza Orijinal Parça No.	Description Descripción Ürün Tanımı	Photo Fotografía Fotoğraf
John Deere MTS 6285	M2283T	SPINDLE THRUST WASHER ARANDELA DEL TREN DELANTERO AKSON PULU	
John Deere MTS 0110	T21669	FRONT AXLE, PIVOT PIN BULÓN EJE DELANTERO ÖN DİNGİL PERNOSU DELİKLİ	
John Deere MTS 19558	T29205	FRONT AXLE, PIVOT PIN BULÓN EJE DELANTERO ÖN DİNGİL PERNOSU DELİKLİ	
John Deere MTS 0480	AL31088R	FRONT AXLE, PIN PIÑÓN DE EJE DELANTERO ÖN DİNGİL PİMİ KONİK	
John Deere MTS 0111	AL19725R	FRONT AXLE, PIN 142,7mm BULÓN DE EJE DELANTERO 142,7mm ÖN DİNGİL PİMİ 142,7mm	

MTSCO Ref.	Part Numbers Números de Pieza Orijinal Parça No.	Description Descripción Ürün Tanımı	Photo Fotografía Fotoğraf
John Deere MTS 0432	AR53392R	FRONT AXLE, PIN 132,8mm BULÓN DE EJE DELANTERO 132,8mm ÖN DİNGİL PİMİ 132,8mm	
John Deere MTS 0433	AL19361R	FRONT AXLE, PIN 168,2mm BULÓN DE EJE DELANTERO 168,2mm ÖN DİNGİL PİMİ 168,2mm	
John Deere MTS 0109	L34070 T21778 L34072 L55437	FRONT AXLE, PIN BULÓN PUENTE DELANTERO SPORT PİMİ	
John Deere MTS 19557	L57726	FRONT AXLE, PIN BULÓN PUENTE DELANTERO SPORT PİMİ	
John Deere MTS 19570	L111817	FRONT AXLE, PIN BULÓN PUENTE DELANTERO SPORT PİMİ	

MTSCO Ref.	Part Numbers Números de Pieza Orijinal Parça No.	Description Descripción Ürün Tanımı	Photo Fotografía Fotoğraf
John Deere MTS 19628	R209081	FRONT AXLE SUPPORT FLANGE SOPORTE EJE DELANTERO ÖN AKS SPORT FLANŞI	
John Deere MTS 19520	AL150416, AL155907, AL159470, AL116581, AL171754, AL119092, AL160479, AL157453	SUSPENSION ROD BIELA SUSPENSIÓN ÖN SÜSPANSİYON LAMASI	
John Deere MTS 19521	RE288103 RE182881	SUSPENSION ROD BIELA SUSPENSIÓN ÖN SÜSPANSİYON LAMASI	
John Deere MTS 0492	L114111	SHEAR PIN 107X30 BULÓN PERNO DE BIELA SUSPENSIÓN 107X30 SÜSPANSİYON LAMA PİMİ 107X30	
John Deere MTS 0493	L114112	SHEAR PIN 92.5X25 BULÓN PERNO DE BIELA SUSPENSIÓN 92.5X25 SÜSPANSİYON LAMA PİMİ 92.5X25	

MTSCO Ref.	Part Numbers Números de Pieza Orijinal Parça No.	Description Descripción Ürün Tanımı	Photo Fotografía Fotoğraf
John Deere MTS 0494	L114113	SHEAR PIN 104X25 BULÓN PERNO DE BIELA SUSPENSIÓN 104X25 SÜSPANSİYON LAMA PİMİ 104X25	
John Deere MTS 0495	L154263	SHEAR PIN 95X30 BULÓN PERNO DE BIELA SUSPENSIÓN 95X30 SÜSPANSİYON LAMA PİMİ 95X30	
John Deere MTS 0496	L166724	SHEAR PIN 100X30 BULÓN PERNO DE BIELA SUSPENSIÓN 100X30 SÜSPANSİYON LAMA PİMİ 100X30	
John Deere MTS 0497	L154263KIT L165327KIT	SHEAR PIN 95X30 KIT JUEGO DE BULÓN PERNO DE BIELA SUSPENSIÓN 95X30 SÜSPANSİYON LAMA PİMİ 95X30 TK.	
John Deere MTS 19449	R113991	PLANETARY RING GEAR CORONA DENTADO INTERIOR ÖN AKS ÇEMBER DİŞLİ	

Replacement Tractor Parts

Piezas de Repuesto del Tractor





Traktör Yedek Parçaları

MTSCO Ref.	Part Numbers Números de Pieza Orijinal Parça No.	Description Descripción Ürün Tanımı	Photo Fotografía Fotoğraf
John Deere MTS 19450	R119586	PLANETARY RING GEAR PLATE CORONA DENTADO EXTERIOR ÖN AKS ÇEMBER DİŞLİ KAPAĞI	
John Deere MTS 19370	RE61882 RE45451	DRIVE SHAFT YOKE HORQUILLA DEL PUENTE DE TRANSMISIÓN MAFSAL KAPLINİ	
John Deere MTS 19489	L157626 L171156	PLANET CARRIER PLANETA PORTADOR PLANET KARIYERİ 3'LÜ	
John Deere MTS 19490	L40041 81454C1 E1NN1N045AA 83927791 ZF4472351020	PLANET CARRIER PLANETA PORTADOR PLANET KARIYERİ 3'LÜ - APL325	
John Deere MTS 19491	L110737 A52143 83944714 87771843 ZF4475317019	PLANET CARRIER PLANETA PORTADOR PLANET KARIYERİ 3'LÜ - APL2060, APL365	

Replacement Tractor Parts

Piezas de Repuesto del Tractor





Traktör Yedek Parçaları



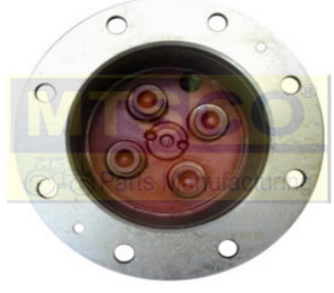

MTSCO Ref.	Part Numbers Números de Pieza Orijinal Parça No.	Description Descripción Ürün Tanımı	Photo Fotografía Fotoğraf
John Deere MTS 19492	L60110 F168302020460	PLANET CARRIER PLANETA PORTADOR PLANET KARIYERİ 3'LÜ - APL735	
John Deere MTS 19493	L40012 81687C1 E2NN1N045AA 83934017 04349976 F198300020620 5213493 ZF4472353077	PLANET CARRIER PLANETA PORTADOR PLANET KARIYERİ 3'LÜ - APL345, APL350	
John Deere MTS 19494	L100242 F510300020570 ZF4475305113	PLANET CARRIER PLANETA PORTADOR PLANET KARIYERİ 3'LÜ - APL2030	
John Deere MTS 19495	L101726 F716300020420 ZF4475306068	PLANET CARRIER PLANETA PORTADOR PLANET KARIYERİ 4'LÜ - APL2045	
John Deere MTS 19496	L112761 04417262 F514300020380 ZF4475306061	PLANET CARRIER PLANETA PORTADOR PLANET KARIYERİ 3'LÜ - APL2045	

Replacement Tractor Parts

Piezas de Repuesto del Tractor

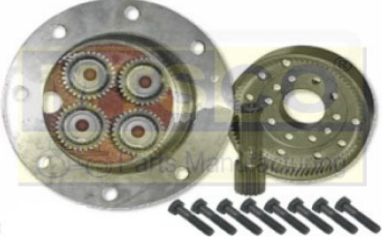
Traktör Yedek Parçaları

MTSCO Ref.	Part Numbers Números de Pieza Orijinal Parça No.	Description Descripción Ürün Tanımı	Photo Fotografía Fotoğraf
John Deere MTS 19497	L41121 83945677 5214384 04350428 ZF4472353183	PLANET CARRIER PLANETA PORTADOR PLANET KARIYERİ 4'LÜ - APL345, APL350	
John Deere MTS 19498	L100168 04415070 F308300021140 ZF4475404050	PLANET CARRIER PLANETA PORTADOR PLANET KARIYERİ 3'LÜ - APL2025	
John Deere MTS 19660	RE45942 81879351 CAR65774	PLANET CARRIER PLANETA PORTADOR PLANET KARIYERİ 3'LÜ	
John Deere MTS 19661	L101726KIT F716300020420KIT ZF4475306068KIT	PLANET CARRIER KIT PLANETA PORTADOR PLANET KARIYERİ 4'LÜ - APL2045 KIT	
John Deere MTS 19662	L116105 ZF4475317049 ZF4475317122	PLANET CARRIER PLANETA PORTADOR PLANET KARIYERİ 3'LÜ - APL2060	

MTSCO Ref.	Part Numbers Números de Pieza Orijinal Parça No.	Description Descripción Ürün Tanımı	Photo Fotografía Fotoğraf
John Deere MTS 19663	L101726KITC, F716300020420KITC, ZF4475306068KITC	PLANET CARRIER PLANETA PORTADOR PLANET KARIYERİ 4'LÜ - APL2045 KIT KOMPLE	
John Deere MTS 19664	R238229 R201555 R169966 R88215 R99681	PLANET CARRIER PLANETA PORTADOR PLANET KARIYERİ 3'LÜ	
John Deere MTS 19665	RE212839	PLANET CARRIER PLANETA PORTADOR PLANET KARIYERİ 3'LÜ	
John Deere MTS 19666	R271422	PLANET CARRIER PLANETA PORTADOR PLANET KARIYERİ 3'LÜ	
John Deere MTS 19667	L166299	PLANET CARRIER PLANETA PORTADOR PLANET KARIYERİ 4'LÜ	

MTSCO Ref.	Part Numbers Números de Pieza Orijinal Parça No.	Description Descripción Ürün Tanımı	Photo Fotografía Fotoğraf
John Deere MTS 19445	L154369	PLANET GEAR Z=39 ENGRANAJE TRANSMISIÓN DE PIÑÓN PLANETARIO Z=39 PLANET DİŞLİ Z=39	
John Deere MTS 19416	L41123	PINION SHAFT Z=18X22 EJE DE PIÑÓN Z=18X22 PİNYON DİŞLİ Z=18X22	
John Deere MTS 19652	AL161290	BEARING RODAMIENTO DE PLANETARIO RULMAN	
John Deere MTS 19458	JD10250	BALL BEARING RODAMIENTO DE PLANETARIO HAS.MİLİ TK. 28mmX508mm 2040 ISLAHLI	
John Deere MTS 0120	AL40976 28mmX508mm Utility/Modelo/Model: 2040	LOAD CONTROL SENSOR SHAFT KIT JUEGO DE EJE DE CONTROL DE CARGA HAS.MİLİ TK. 28mmX508mm 2040 ISLAHLI	

MTSCO Ref.	Part Numbers Números de Pieza Orijinal Parça No.	Description Descripción Ürün Tanımı	Photo Fotografía Fotoğraf
John Deere MTS 0091/A	L26932 T26598 Utility/Modelo/Model: 1130	LOAD CONTROL SENSOR SHAFT EJE DE CONTROL DE CARGA HAS.MİLİ 1130 ISLAHLI	 
John Deere MTS 0092/A	L31199 25,5mmX497mm Utility/Modelo/Model: 2030	LOAD CONTROL SENSOR SHAFT EJE DE CONTROL DE CARGA HAS.MİLİ 25,5mmX497mm 2030 ISLAHLI	 
John Deere MTS 0093/A	L41787 28mmX508mm Utility/Modelo/Model: 2040	LOAD CONTROL SENSOR SHAFT EJE DE CONTROL DE CARGA HAS.MİLİ 28mmX508mm 2040 ISLAHLI	 
John Deere MTS 0094/A	L41819 28mmX575mm Utility/Modelo/Model: 2040	LOAD CONTROL SENSOR SHAFT EJE DE CONTROL DE CARGA HAS.MİLİ 28mmX575mm 2040 ISLAHLI	 
John Deere MTS 0309	L41197 28mmX641mm Utility/Modelo/Model: 4140	LOAD CONTROL SENSOR SHAFT EJE DE CONTROL DE CARGA HAS.MİLİ 28mmX641mm 4140 ISLAHLI	 

MTSCO Ref.	Part Numbers Números de Pieza Orijinal Parça No.	Description Descripción Ürün Tanımı	Photo Fotografía Fotoğraf
John Deere MTS 26008	R46513 28,55mmX538mm	LOAD CONTROL SENSOR SHAFT EJE DE CONTROL DE CARGA HAS.MİLİ 28,55mmX538mm	
John Deere MTS 26009	L26940 25,40mmX581mm	LOAD CONTROL SENSOR SHAFT EJE DE CONTROL DE CARGA HAS.MİLİ 25,40mmX581mm (= MTS 0441)	
John Deere MTS 26010	L26937 22,27mmX494,28mm	LOAD CONTROL SENSOR SHAFT EJE DE CONTROL DE CARGA HAS.MİLİ 22,27mmX494,28mm	
John Deere MTS 0444	AL40978 28mmX575mm Utility/Modelo/Model: 3140	LOAD CONTROL SENSOR SHAFT KIT JUEGO DE EJE DE CONTROL DE CARGA HAS.MİLİ TK. 28mmX575mm 3140 ISLAHLI	
John Deere MTS 26046	L41197KIT 28mmX641mm	LOAD CONTROL SENSOR SHAFT KIT JUEGO DE EJE DE CONTROL DE CARGA HAS.MİLİ TK. 28mmX641mm	





Replacement Tractor Parts

Piezas de Repuesto del Tractor





Traktör Yedek Parçaları

MTSCO Ref.	Part Numbers Números de Pieza Orijinal Parça No.	Description Descripción Ürün Tanımı	Photo Fotografía Fotoğraf
John Deere MTS 0095	L41196 Utility/Modelo/Model: 2040	LOAD CONTROL SENSOR SHAFT BUSHING BUJE EJE CONTROL DE CARGA HAS.MİLİ KEÇE YATAĞI 2040	
John Deere MTS 0096	T28546 Utility/Modelo/Model: 2030- 2130	LOAD CONTROL SENSOR SHAFT BUSHING BUJE EJE CONTROL DE CARGA HAS.MİLİ KEÇE YATAĞI 2030-2130	
John Deere MTS 0097	T22097 Utility/Modelo/Model: 1030- 1130	LOAD CONTROL SENSOR SHAFT BUSHING BUJE EJE CONTROL DE CARGA HAS.MİLİ KEÇE YATAĞI 1030-1130	
John Deere MTS 26007	L41802 28mm	LOAD CNTRL.SENSOR SHAFT BUSHING DBL.GROOVE BUJE EJE CONTROL DE CARGA RANURA DE DOBLE HAS.MİLİ KEÇE YATAĞI ÇİFT KANAL-28mm	
John Deere MTS 0098	T22099 Utility/Modelo/Model: 1130	LOAD CONTROL SENSOR SHAFT BUSHING CASQUILLO REDUCTOR HAS.MİLİ BURCU YARIKLI 1130	

Replacement Tractor Parts
Piezas de Repuesto del Tractor
Traktör Yedek Parçaları

MTSCO Ref.	Part Numbers Números de Pieza Orijinal Parça No.	Description Descripción Ürün Tanımı	Photo Fotografía Fotoğraf
John Deere MTS 0099	T28548 Utility/Modelo/Model: 2030	LOAD CONTROL SENSOR SHAFT BUSHING CASQUILLO REDUCTOR HAS.MİLİ BURCU YARIKLI 2030	
John Deere MTS 0102	L26933KIT Ø20,5mm Utility/Modelo/Model: 1030/1130 incl./incluye/içeriği: L26933 Bushing/Casquillo/Burç L26936 Clamp/Pinza/Kelepçe L26935 Pin/Perno/Pin	LOAD CONTROL DRAFT LINK BUSHING KIT CASQUILLO CONJUNTO CIERRE EJE HAS.MİLİ TAKOZU TK. ÇAP 20,5mm 1030/1130	
John Deere MTS 0100	L26941KIT Ø25,5mm Utility/Modelo/Model: 2030/2130 incl./incluye/içeriği: L26941 Bushing/Casquillo/Burç L26936 Clamp/Pinza/Kelepçe L26943 Pin/Perno/Pin	LOAD CONTROL DRAFT LINK BUSHING KIT CASQUILLO CONJUNTO CIERRE EJE HAS.MİLİ TAKOZU TK. ÇAP 25,5mm 2030/2130	
John Deere MTS 0101	L41788KIT Ø28,1mm Utility/Modelo/Model: 2040/2140 incl./incluye/içeriği: L41788 Bushing/Casquillo/Burç L26936 Clamp/Pinza/Kelepçe L26943 Pin/Perno/Pin	LOAD CONTROL DRAFT LINK BUSHING KIT CASQUILLO CONJUNTO CIERRE EJE HAS.MİLİ TAKOZU TK. ÇAP 28,1mm 2040/2140	
John Deere MTS 0316	L26933 Ø20,5mm	LOAD CONTROL DRAFT LINK BUSHING CASQUILLO CONJUNTO CIERRE EJE HAS.MİLİ TAKOZU DIŞTAN KANALLI 20,5mm	

Replacement Tractor Parts
Piezas de Repuesto del Tractor
Traktör Yedek Parçaları

MTSCO Ref.	Part Numbers Números de Pieza Orijinal Parça No.	Description Descripción Ürün Tanımı	Photo Fotografía Fotoğraf
John Deere MTS 0328	L26941 Ø25,5mm	LOAD CONTROL DRAFT LINK BUSHING CASQUILLO CONJUNTO CIERRE EJE HAS.MİLİ TAKOZU DIŞTAN KANALLI 25,5mm	
John Deere MTS 0329	L41788 Ø28,1mm	LOAD CONTROL DRAFT LINK BUSHING CASQUILLO CONJUNTO CIERRE EJE HAS.MİLİ TAKOZU DIŞTAN KANALLI 28,1mm	
John Deere MTS 0103	L26935 8,0mm	LOAD CONTROL DRAFT LINK PIN PASADOR DE EJE DE CONTROL DE CARGA HAS.MİLİ TAKOZ PİMİ 8,0mm	
John Deere MTS 0121	L26943 9,5mm	LOAD CONTROL DRAFT LINK PIN PASADOR DE EJE DE CONTROL DE CARGA HAS.MİLİ TAKOZ PİMİ 9,5mm	
John Deere MTS 0104	L26936	LOAD CONTROL DRAFT LINK CLAMP GRUPILLA DE EJE DE CONTROL DE CARGA HAS.MİLİ TAKOZ PİMİ SEGMANI	





Replacement Tractor Parts





Piezas de Repuesto del Tractor

Traktör Yedek Parçaları





MTSCO Ref.	Part Numbers Números de Pieza Orijinal Parça No.	Description Descripción Ürün Tanımı	Photo Fotografía Fotoğraf
John Deere MTS 0339	L41154	LOAD CONTROL SENSOR SHAFT WASHER ARANDELA DE HIERRO DE EJE DE CONTROL DE CARGA HASSASİYET MİLİ PULU	
John Deere MTS 26045	R108090	LOAD CONTROL SENSOR SHAFT PIN BULÓN DE EJE DE CONTROL HASSASİYET MİL PİMİ	
John Deere MTS 9325	AL180110	DRAWBAR PIN PERNO BULÓN TENSOR DE REMOLQUE ÇEKİ OKU PİMİ	
John Deere MTS 9244	L79924	LEVELLING BOX BALL PIN BULÓN / PASADOR DE BOLA DE CAJA NIVELADORA AYAR KOL AŞIĞI PİMİ	
John Deere MTS 30220	AL31229	FRONT WEIGHT PIN w/L12491 BULÓN CONTRAPESOS CON ANILLA L12491 ÖN AĞIRLIK PİMİ KOPİLYALI	

Replacement Tractor Parts
Piezas de Repuesto del Tractor
Traktör Yedek Parçaları

MTSCO Ref.	Part Numbers Números de Pieza Orijinal Parça No.	Description Descripción Ürün Tanımı	Photo Fotografía Fotoğraf
John Deere MTS 6652	L33910 220mm x 306mm x 50mm	BRAKE PISTON PISTÓN DE FRENO FREN PİSTONU 306x220x50	
John Deere MTS 6655	L101856	BRAKE PISTON PISTÓN DE FRENO FREN PİSTONU	
John Deere MTS 6660	L111978	BRAKE PISTON PISTÓN DE FRENO FREN PİSTONU	
John Deere MTS 6664	R125127	BRAKE PISTON PISTÓN DE FRENO FREN PİSTONU	
John Deere MTS 6656	L33497 L56247 6mm	BRAKE PISTON PLACA DE FRENO FREN PLEYTİ 7mm	

MTSCO Ref.	Part Numbers Números de Pieza Orijinal Parça No.	Description Descripción Ürün Tanımı	Photo Fotografía Fotoğraf
John Deere MTS 6657	L55079 10mm	BRAKE PISTON PLACA DE FRENO FREN PLEYTİ 10mm	
John Deere MTS 6658	L33481 L55004 14mm	BRAKE PISTON PLACA DE FRENO FREN PLEYTİ 14mm	
John Deere MTS 6659	L77358	BRAKE PISTON PLACA DE FRENO FREN PLEYTİ	
John Deere MTS 6661	L114092 28,0mm	BRAKE PISTON PLACA DE FRENO FREN PLEYTİ 28,0mm	
John Deere MTS 6662	L114091 21,5mm	BRAKE PISTON PLACA DE FRENO FREN PLEYTİ 21,5mm	







Replacement Tractor Parts
Piezas de Repuesto del Tractor
Traktör Yedek Parçaları

MTSCO Ref.	Part Numbers Números de Pieza Orijinal Parça No.	Description Descripción Ürün Tanımı	Photo Fotografía Fotoğraf
John Deere MTS 6663	L114053 22,0mm	BRAKE PISTON PLACA DE FRENO FREN PLEYTİ 22,0mm	
John Deere MTS 6665	R125128 17,45mm	BRAKE PISTON PLACA DE FRENO FREN PLEYTİ 17,45mm	
John Deere MTS 6666	R331779 R240743	BRAKE PISTON PLACA DE FRENO FREN PLEYTİ	
John Deere MTS 6667	R331780 R240961	BRAKE PISTON PLACA DE FRENO FREN PLEYTİ	
John Deere MTS 6668	R124067	BRAKE PISTON PLACA DE FRENO FREN PLEYTİ	

Replacement Tractor Parts

Piezas de Repuesto del Tractor

Traktör Yedek Parçaları







MTSCO Ref.	Part Numbers Números de Pieza Orijinal Parça No.	Description Descripción Ürün Tanımı	Photo Fotografía Fotoğraf
John Deere MTS 6669	R211951	BRAKE PISTON PLACA DE FRENO FREN PLEYTİ	
John Deere MTS 0112	AL23836 AL67574 AL69179 AL70242	BRAKE, CHECK VALVE RETENCIÓN BLOQUE CONTROLAR VÁLVULA DEL FRENO FREN MERKEZ VALFİ	
John Deere MTS 0001	RE35685 RE55343	OIL PUMP BOMBA DE ACEITE YAĞ POMPASI	
John Deere MTS 0002	AR62979	OIL PUMP HOUSING CARCASA DE BOMBA DE ACEITE YAĞ POMPA GÖVDESİ	
John Deere MTS 0003	R53382	OIL PUMP COVER CUBIERTA DE LA BOMBA DE ACEITE YAĞ POMPA KAPAĞI, AÇILI	
John Deere MTS 0004	AR62978	OIL PUMP GEAR & PINION ENGRANAJE Y PIÑÓN DE LA BOMBA DE ACEITE YAĞ POMPA DİŞLİSİ UZUN SAPLI	

Replacement Tractor Parts

Piezas de Repuesto del Tractor

Traktör Yedek Parçaları

MTSCO Ref.	Part Numbers Números de Pieza Orijinal Parça No.	Description Descripción Ürün Tanımı	Photo Fotografía Fotoğraf
John Deere MTS 0005	R54614	OIL PUMP GEAR ENGRANAJE DE LA BOMBA DE ACEITE YAĞ POMPA DİŞLİSİ KISA	
John Deere MTS 3450	RE52020	OIL PUMP KIT JUEGO DE BOMBA DE ACEITE YAĞ POMPASI TK.	
John Deere MTS 3452	RE504914	OIL PUMP BOMBA DE ACEITE YAĞ POMPASI	
John Deere MTS 3459	DD14760	OIL PUMP BOMBA DE ACEITE YAĞ POMPASI	
John Deere MTS 3460	R113751	OIL PUMP COVER CUBIERTA DE LA BOMBA DE ACEITE YAĞ POMPA KAPAĞI, DÜZ	
John Deere MTS 0122	AT31250 AR103769 RE19031 AT18129 AT22665	ROCKER ARM w/screw BRAZO DE BALANCÍN COLOCAR PİYANO TUŞU CIVATALI	
John Deere MTS 0475	T32213	ROCKER ARM SCREW TORNILLO DEL BALANCÍN PİYANO TUŞU CIVATASI	

MTSCO Ref.	Part Numbers Números de Pieza Orijinal Parça No.	Description Descripción Ürün Tanımı	Photo Fotografía Fotoğraf
John Deere MTS 0006	T30413	CRANKSHAFT WEAR RING CIGÜEÑAL ANILLO DELANTERO KRANK KEÇE BAGASI	
John Deere MTS 26053	R111186	LOAD CONTROL SENSOR SHAFT 645 mm EJE DE CONTROL DE CARGA 645 mm HAS MİLİ ISLAHLI 645 mm	
John Deere MTS 26047	R108085	LOAD CONTROL SENSOR SHAFT 670 mm EJE DE CONTROL DE CARGA 670 mm HAS MİLİ ISLAHLI 670 mm	
John Deere MTS 26048	R71375	LOAD CONTROL SENSOR SHAFT EJE DE CONTROL DE CARGA HAS MİLİ ISLAHLI	
John Deere MTS 26205K	AL 172261	HITCH VALVE KIT JUEGO DE VÁLVULA HÍDRÁULICA DISTRIBUIDOR SELLEKTÖR VALF GÖVDESİ KIT	
John Deere MTS 35165	L42187	PUMP DRIVE SHAFT KEYED TYPE 250mm EJE DE TRANSMISIÓN / ACCIONAMIENTO DE BOMBA, ESTRIADO 250mm HÍD.POMPA ŞAFT KAMALI TIP 250MM	

Replacement Tractor Parts

Piezas de Repuesto del Tractor

Traktör Yedek Parçaları

MTSCO Ref.	Part Numbers Números de Pieza Orijinal Parça No.	Description Descripción Ürün Tanımı	Photo Fotografía Fotoğraf
John Deere MTS 22138	RE39406	TRANS.PUMP INPUT SHAFT, w/bushing EJE DE ENTRADA DE LA BOMBA DE TRANSFERENCIA con buje ŞANZ.POMPA ŞAFTI, BURÇ DAHİL	
John Deere MTS 26322	L34572	PUMP DRIVE SHAFT KEYED TYPE 198mm EJE DE TRANSMISIÓN / ACCIONAMIENTO DE BOMBA, ESTRIADO 198mm HİD.POMPA ŞAFTI KAMALI TİP 198mm	
John Deere MTS 33500	E98137	ACCELERATOR,REPLACE S RIGHT, CW ACELERADOR MOCO SENTIDO HORARIO BAĞLANTI LAMASI SAĞ	
John Deere MTS 33501	E98138	ACCELERATOR LEFT COUNTER-CLOCKWISE ACELERADOR MOCO SENTIDO ANTIHORARIO BAĞLANTI LAMASI SOL	
John Deere MTS 33502	DC56280	CAM LEFT EXCENTRICA RECOJEDOR IZQUIERDA KAMPANA SOL	

Replacement Tractor Parts

Piezas de Repuesto del Tractor

Traktör Yedek Parçaları

MTSCO Ref.	Part Numbers Números de Pieza Orijinal Parça No.	Description Descripción Ürün Tanımı	Photo Fotografía Fotoğraf
John Deere MTS 33503	CC25220	RİNG - BUSHING CASQUILLO - BUJE SARSAK BURCU	
John Deere MTS 33504	N282536	PIVOT PIN PIÑÓN DE PIVOTE KOL PİMİ	
John Deere MTS 33505	AE71036	DISC SHEAR HUB DRIVER KIT PLATINA DE CUCHILLAS MOCO KAPAK TAKIMI	
John Deere MTS 33506	DC56282	CAM RIGHT EXCENTRICA RECOJEDOR DERECHA KAMPANA SAĞ	
John Deere MTS 35209	RE44027	TRANS.PUMP INPUT SHAFT, w/bushing EJE DE ENTRADA DE LA BOMBA DE TRANSFERENCIA con buje ŞANZ.POMPA ŞAFTI, BURÇ DAHİL	

Replacement Tractor Parts
Piezas de Repuesto del Tractor
Traktör Yedek Parçaları

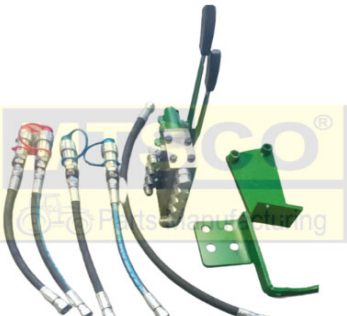
MTSCO Ref.	Part Numbers Números de Pieza Orijinal Parça No.	Description Descripción Ürün Tanımı	Photo Fotografía Fotoğraf
John Deere MTS 0366/TK	AL34593 AL34595	SELECTIVE CONTROL VALVE VÁLVULA DE CONTROL SELECTIVO DAMPER VALFİ ÇİFT ÇIKIŞLI KOLLU/HORTUM BAĞLANTILI	
John Deere MTS 0393/TK	AL34595	SELECTIVE CONTROL VALVE VÁLVULA DE CONTROL SELECTIVO DAMPER VALFİ TEK ÇIKIŞLI (KÖRLEME)	
John Deere			
John Deere			

MTSCO Ref.

Part Numbers
Números de Pieza
Orijinal Parça No.Description
Descripción
Ürün TanımıPhoto
Fotografía
Fotoğraf**MTS 0180 BALANCER SPARE PARTS
MTS 0180 RECAMBIOS DE EQUILBRADOR / BALANCEADOR
MTS 0180 BALANSİYER PARÇALARI**

MTS 0180

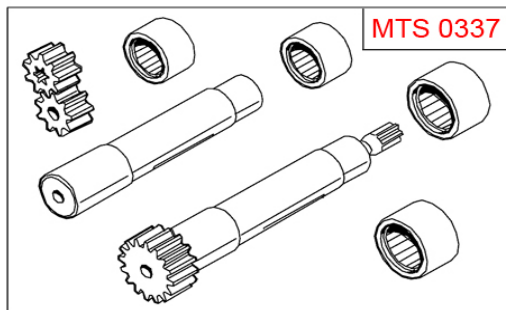
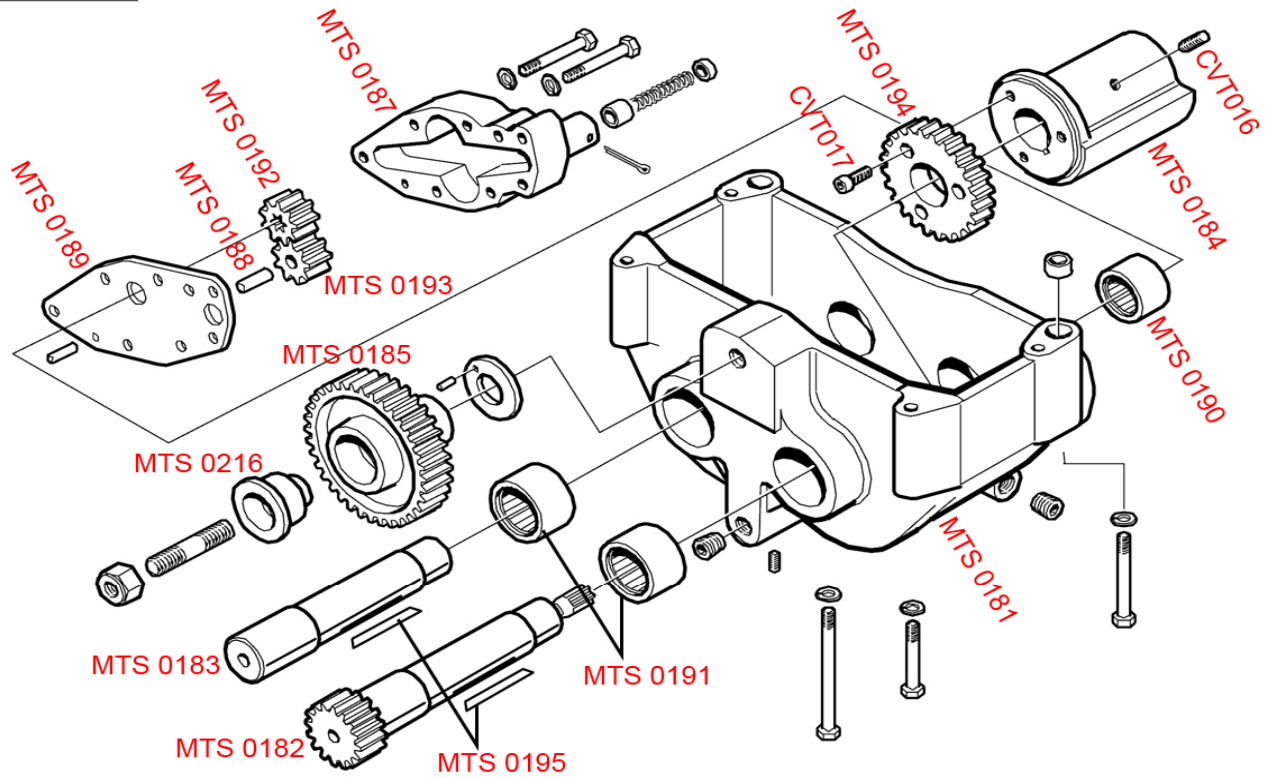

Replacement Tractor Parts

Piezas de Repuesto del Tractor

Traktör Yedek Parçaları

MTSCO Ref.

Part Numbers
Números de Pieza
Orijinal Parça No.Description
Descripción
Ürün TanımıPhoto
Fotografía
Fotoğraf

MTS 0197 BALANCER SPARE PARTS



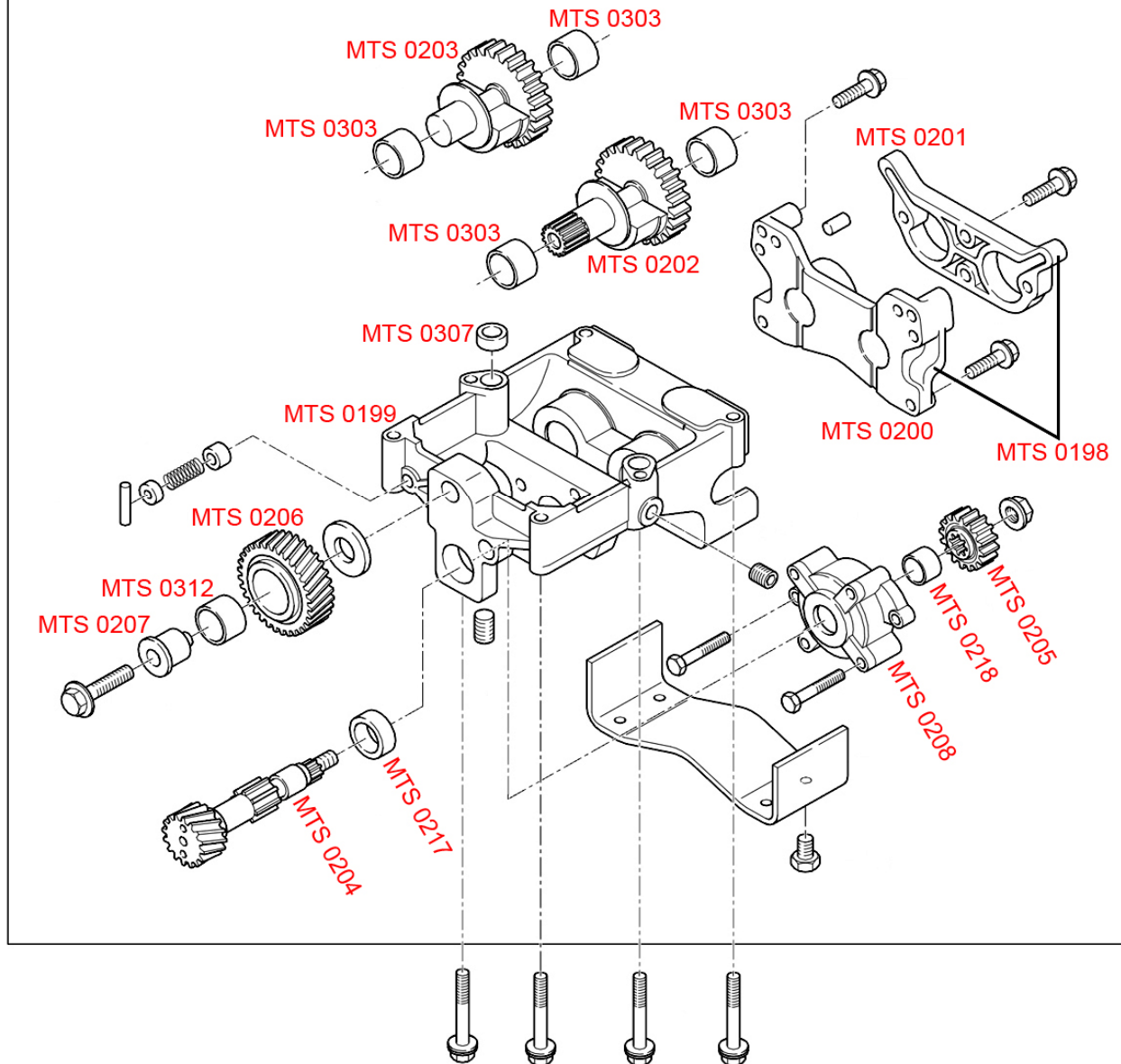

MTS 0197 RECAMBIOS DE EQUILIBRADOR / BALANCEADOR

MTS 0197 BALANSİYER PARÇALARI

MTS 0197



MTSCO Ref.	Part Numbers Números de Pieza Orijinal Parça No.	Description Descripción Ürün Tanımı	Photo Fotografía Fotoğraf
Massey Ferguson MTS 0180	Ford New Holland: 505599 Massey Ferguson: 743432M91 746432M91 Perkins: 41733066, 41733082	BALANCER UNIT (4 bolt fixing) BALANCEADOR COMPLETO (4 tornillos de fijación) BALANSİYER (4 Bağl.)	
Massey Ferguson MTS 0181	37527281	BALANCER HOUSING (4 bolt fixing) BALANCEADOR Vacío (4 tornillos de fijación) BALANSİYER GÖVDESİ (4 Bağl.)	
Massey Ferguson MTS 0182	Ford New Holland: 505518, Massey Ferguson: 743137M1, Not Specified: 743 137M1, Perkins: 31171272, 31171275, 31171276	BALANCER DRIVE SHAFT long EJE DE TRANSMISIÓN / CONDUCTOR EQUILIBRADOR Largo ŞAFT TAHRİK MİLİ (4 Bağl.)	
Massey Ferguson MTS 0183	Ford New Holland: 505534, Massey Ferguson: 743115M1, Perkins: 32731127	BALANCER DRIVE SHAFT short EJE DE TRANSMISIÓN / CONDUCTOR EQUILIBRADOR Corto ŞAFT MİLİ DÜZ (4 Bağl.)	
Massey Ferguson MTS 0195	Massey Ferguson: 2576675, 376588X1, Perkins: 2576675	BALANCER DRIVE SHAFT KEY LLAVE DEL EJE DEL CONTRAPESO AĞIRLIK KAMASI (4 Bağl.)	





MTSCO Ref.	Part Numbers Números de Pieza Orijinal Parça No.	Description Descripción Ürün Tanımı	Photo Fotografía Fotoğraf
Massey Ferguson MTS 0184	37417472 37417474	BALANCER WEIGHT PESO DE BALANCEADOR / EQUILIBRADOR BALANS.AĞIRLIĞI (4 Bağl.)	
Massey Ferguson MTS 0278	2171225 376118X1	BALANCER WEIGHT SCREW TORNILLO DEL PESO DE BALANCEADOR / EQUILIBRADOR BALANS.AĞIRLIK CIVATASI (4 Bağl.)	
Massey Ferguson MTS 0279	2172513 376192X1	BALANCER GEAR SCREW TORNILLO DEL ENGRANAJE EQUILIBRADOR BALANS.AĞIRLIK DİŞLİ CIVATASI (4 Bağl.)	
Massey Ferguson MTS 0194	31164582 746694M1 71340052 31164581	BALANCER GEAR ENGRANAJE DE CONTRAPESO BALANS.AĞIRLIK DİŞLİSİ (4 Bağl.)	
Massey Ferguson MTS 0185	84447	BALANCER GEAR, IDLER ENGRANAJE DE BALANCEADOR AVARE DİŞLİSİ (4 Bağl.)	





MTSCO Ref.	Part Numbers Números de Pieza Orijinal Parça No.	Description Descripción Ürün Tanımı	Photo Fotografía Fotoğraf
Massey Ferguson MTS 0186	3372784	BALANCER GEAR, IDLER BUSHING CASQUILLO ENGRANAJE DEL EQUILIBRADOR AVARE DİŞLİSİ BRONZ BURC (4 Bağl.)	
Massey Ferguson MTS 0216	33451801 734905M2 33458101	BALANCER GEAR HUB BUJE DE ENGRANAJE BALANCEADOR AVARE DİŞLİ GÖBEĞİ (4 Bağl.)	
Massey Ferguson MTS 0190	Ford New Holland: 505506, Massey Ferguson: 746696M1, Perkins: 2557176, 2557181	BALANCER BEARING big RODAMIENTO DE EQUILIBRIO grande BALANSİYER RULMANI BÜYÜK (4 Bağl.)	
Massey Ferguson MTS 0191	Ford New Holland: 505507, Massey Ferguson: 746697M1, Perkins: 2557180, 2557182	BALANCER BEARING small RODAMIENTO DE EQUILIBRIO pequeño BALANSİYER RULMANI KÜÇÜK (4 Bağl.)	
Massey Ferguson MTS 0337	31171276KIT incl./incluye/içeriği: 31171276, 32731127, 31165531, 31165461, 2557182 (2 pcs.), 2557181 (2 pcs.), 2576675 (2 pcs.)	BALANCER UNIT REP.KIT JUEGO DE REPARACIÓN DEL EQUILIBRADOR BALANSİYER TM.TK. (4 Bağl.)	

Replacement Tractor Parts

Piezas de Repuesto del Tractor

Traktör Yedek Parçaları





MTSCO Ref.	Part Numbers Números de Pieza Orijinal Parça No.	Description Descripción Ürün Tanımı	Photo Fotografía Fotoğraf
Massey Ferguson MTS 0214	-	OIL PUMP KIT JUEGO DE BOMBA DE ACEITE YAĞ POMPA GÖVDESİ KOMPLETE (4 Bağl.)	
Massey Ferguson MTS 0187	37714234	OIL PUMP BODY CUERPO DE LA BOMBA DE ACEITE YAĞ POMPA DİŞLİ GÖVDESİ (4 Bağl.)	
Massey Ferguson MTS 0189	36237156	OIL PUMP PLATE PLACA DEL COMPENSADOR DE LA BOMBA DE ACEITE YAĞ POMPA SAC KULAK (4 Bağl.)	
Massey Ferguson MTS 0192	Ford New Holland: 505517, Massey Ferguson: 743020M1, Perkins: 31165121, 31165531	OIL PUMP GEAR splined ENGRANAJE DE CONTRAPESO DE LA BOMBA DE ACEITE estriado YAĞ POMPA DİŞLİSİ FREZELİ (4 Bağl.)	
Massey Ferguson MTS 0193	Ford New Holland: 505516, Massey Ferguson: 734850M1, Not Specified: 734 850M1, Perkins: 31165461	OIL PUMP GEAR plain ENGRANAJE SENCILLO DE LA BOMBA DE ACEITE DEL CONTRAPESO YAĞ POMPA DİŞLİSİ DÜZ 4.BAĞL.	

MTSCO Ref.	Part Numbers Números de Pieza Orijinal Parça No.	Description Descripción Ürün Tanımı	Photo Fotografía Fotoğraf
Massey Ferguson MTS 0188	Massey Ferguson: 734849M1, Perkins: 32455123	OIL PUMP GEAR PIN EJE LOCO DE LA BOMBA DE ACEITE YAĞ POMPA DİŞLİ PİMİ (4 Bağl.)	
Massey Ferguson MTS 0196	32712715 736510M1	OIL PUMP PLUNGER JUEGO DEL ÉMBOLO DEL CONTRAPESO YAĞ P.KPK BASINÇ VALF TM.TK. (4 Bağl.)	
Massey Ferguson MTS 0197	Massey Ferguson: 3637352M91, 3637353M91, 3638368M91, 4224107M91, 4224110M91, Perkins: 4111K011, 4111K022, 4111K026, 4111K028, 4111K035, 4111K037, 4111K038, 4111K041, 4111K051, 4111K053, 4111K055, 4111K059	BALANCER UNIT (6 bolt fixing) BALANCEADOR COMPLETO (6 tornillos de fijación) BALANSİYER (6 Bağl.)	
Massey Ferguson MTS 0198	4145L007	BALANCER FRAME W/REAR COVER EL BASTIDOR DEL BALANCEADOR CON CUBIERTA TRASERA BALANSİYER GÖVDESİ KOMPLE (6 Bağl.)	
Massey Ferguson MTS 0199	37520012	BALANCER FRAME EL BASTIDOR DEL BALANCEADOR BALANSİYER GÖVDESİ (6 Bağl.)	

Replacement Tractor Parts

Piezas de Repuesto del Tractor

Traktör Yedek Parçaları





MTSCO Ref.	Part Numbers Números de Pieza Orijinal Parça No.	Description Descripción Ürün Tanımı	Photo Fotografía Fotoğraf
Massey Ferguson MTS 0200	3753R042	BALANCER REAR COVER CUBIERTA TRASERA DE BALANCEADOR BALANSİYER ARKA GÖVDE (6 Bağl.)	
Massey Ferguson MTS 0201	3753R061	BALANCER REAR COVER CAP TAPA DE LA CUBIERTA TRASERA DEL BALANCEADOR BALANSİYER ARKA GÖVDE KAP.(6 Bağl.)	
Massey Ferguson MTS 0202	3116K014	BALANCER GEAR splined ENGRANAJE EQUILIBRADOR Estriado BALANSİYER AĞIRLIĞI FREZELİ (6 Bağl.)	
Massey Ferguson MTS 0203	3116K004	BALANCER GEAR plain ENGRANAJE EQUILIBRADOR Sencillo BALANSİYER AĞIRLIĞI DÜZ (6 Bağl.)	
Massey Ferguson MTS 3264	3116K014+3116K004	BALANCER WEIGHT SET JUEGO DE PESAS EQUILIBRADOR BALANSİYER AĞIRLIĞI TK. (6 Bağl.)	





Replacement Tractor Parts





Piezas de Repuesto del Tractor





Traktör Yedek Parçaları

MTSCO Ref.	Part Numbers Números de Pieza Orijinal Parça No.	Description Descripción Ürün Tanımı	Photo Fotografía Fotoğraf
Massey Ferguson MTS 0303	2511A730	BALANCER BUSH BUJE BALANCEADOR BALANSİYER BURCU YM.	
Massey Ferguson MTS 0206	3117C071	BALANCER GEAR big ENGRANAJE BALANCEADOR Grande AVARE DİŞLİ (6 Bağl.)	
Massey Ferguson MTS 0207	33451804 747769M1	BALANCER GEAR HUB BUJE DE ENGRANAJE BALANCEADOR AVARE DİŞLİ GÖBEĞİ (6 Bağl.)	
Massey Ferguson MTS 0312	2551A201	BALANCER GEAR BEARING RODAMIENTO AGUJAS DE ENGRANAJES BALANCEADOR AVARE DİŞLİ RULMANI (6 Bağl.)	
Massey Ferguson MTS 0307	33137408	BALANCER THIMBLE ANILLO DE BALANCEADOR BALANSİYER MERKEZLEME KAFESİ	

MTSCO Ref.	Part Numbers Números de Pieza Orijinal Parça No.	Description Descripción Ürün Tanımı	Photo Fotografía Fotoğraf
Massey Ferguson MTS 0204	3117V003 3637593M1	BALANCER SHAFT EJE CONDUCTOR EQUILIBRADOR PRİZDİREK TAHRİK MİLİ (6 Bağl.)	
Massey Ferguson MTS 0205	3116W001	BALANCER GEAR small ENGRANAJE BALANCEADOR Pequeño PİRİZDİREK PİYON DİŞLİSİ (6 Bağl.)	
Massey Ferguson MTS 0217	2551A009	BALANCER SHAFT BEARING RODAMIENTO DE AGUJAS DE BALANCEADOR BLNS.PRİZD.RULMANI BÜYÜK (6 Bağl.)	
Massey Ferguson MTS 0218	2551A014	BALANCER SHAFT BEARING RODAMIENTO DE AGUJAS DE BALANCEADOR BLNS.PRİZD.RULMANI KÜÇÜK (6 Bağl.)	
Massey Ferguson MTS 0420	-	BALANCER OIL RELIEF VALVE SET JUEGO DE VÁLVULAS DE ALIVIO DE ACEITE BALANCEADOR BALANSİYER VALF TM.TK. (6 Bağl.)	

MTSCO Ref.	Part Numbers Números de Pieza Orijinal Parça No.	Description Descripción Ürün Tanımı	Photo Fotografía Fotoğraf
Massey Ferguson MTS 12100	4111K073 4225009M1	BALANCER UNIT BALANCEADOR DE MOTOR BALANSİYER 1104	
Massey Ferguson MTS 12101	U5MK0695	BALANCER OIL RELIEF VALVE SET JUEGO DE VÁLVULAS DE ALIVIO DE ACEITE DEL EQUILIBRADOR BALANSİYER VALF TM.TK. 1104	
Massey Ferguson MTS 0208	Case/IH: 293177A1, Massey Ferguson: 3637489M91, Perkins: 4132F021, 4132F041	OIL PUMP BOMBA DE ACEITE YAĞ POMPASI (6 Bağl.)	
Massey Ferguson MTS 0212	Ford New Holland: 505519, JCB: 02190002, Massey Ferguson: 736254M1, Perkins: 31171353	CAMSHAFT GEAR ENGRANAJE DEL EJE DE TRANSMISIÓN EKSANTİRİK MİL DİŞLİ	
Massey Ferguson MTS 0213	Ford New Holland: 505594, JCB: 02190003, Massey Ferguson: 3637075M91, 734738M91, Perkins: 41115023	IDLER GEAR ENGRANAJE INTERMEDIO DEL CIGUEÑAL AVARE DİŞLİSİ SARI BURÇLU	

MTSCO Ref.	Part Numbers Números de Pieza Orijinal Parça No.	Description Descripción Ürün Tanımı	Photo Fotografía Fotoğraf
Massey Ferguson MTS 0211	1696239M92	SELECTIVE CONTROL VALVE ASSY. w/long lever (2outlets) VÁLVULA DEL AISLANTE con palanca larga (2Puertos) DAMPER VALFİ ÇİFT YÖNLÜ, UZUN KOLLU	
Massey Ferguson MTS 28157	1696239M92KIT	SELECTIVE CNTRL.VALVE ASSY.KIT, w/long lever (2outlets) KIT JUEGO DE VÁLVULA DEL AISLANTE con palanca larga (2Puertos) DAMPER VALFİ ÇİFT YÖNLÜ TK., UZUN KOLLU	
Massey Ferguson MTS 28150	1696239M92S	SELECTIVE CONTROL VALVE ASSY. w/short lever (2outlets) VÁLVULA DEL AISLANTE con palanca corta (2Puertos) DAMPER VALFİ ÇİFT YÖNLÜ, KISA KOLLU	
Massey Ferguson MTS 28158	1696239M92SKIT	SELECTIVE CONTROL VALVE ASSY. w/short lever (2outlets) KIT JUEGO DE VÁLVULA DEL AISLANTE con palanca corta (2Puertos) DAMPER VALFİ ÇİFT YÖNLÜ TK., KISA KOLLU	
Massey Ferguson MTS 28155	1684806	SELECTIVE CONTROL VALVE HOSE KIT JUEGO DE MANGUERA DE VÁLVULA DE CONTROL SELECTIVO DAMPER VALFİ HORTUM SETİ	

MTSCO Ref.	Part Numbers Números de Pieza Orijinal Parça No.	Description Descripción Ürün Tanımı	Photo Fotografía Fotoğraf
Massey Ferguson MTS 0215	3612562M94 423050M91 4200050M91 805975	IPTO CLUTH ASSY PAQUETE DE EMBRAGUES IPTO (TOMA DE POTENCIA INTERNA) KOMPLE TORK	
Massey Ferguson MTS 7523	364689X1	IPTO CLUTCH SNAP RING (for MTS 0215) ANILLO A PRESIÓN DE EMBRAGUE IPTO (para MTS 0215) PTO TORK VOLAN SEKMANI (MTS 0215 için)	
Massey Ferguson MTS 0306	3610279M2	PTO SHAFT SUPPORT SOPORTE DEL EJE DE LA TOMA DE FUERZA PTO KEPÇESİ	
Massey Ferguson MTS 0219	1870860M1 513242M1 772893M91	IPTO CLUTH, STEEL DISC PLACA DE ACERO IPTO (TOMA DE POTENCIA INTERNA) TORK SACI PLAKASI KALIN	
Massey Ferguson MTS 0304	1870011M1	IPTO CLUTH, SHIM 0,76mm PLACA DE ACERO IPTO (TOMA DE POTENCIA INTERNA) PTO KAVRAMA PLAKASI	

MTSCO Ref.	Part Numbers Números de Pieza Orijinal Parça No.	Description Descripción Ürün Tanımı	Photo Fotografía Fotoğraf
Massey Ferguson MTS 0305	1672626M1, 1862289M2, 1869665M1, 1870074M1, 1870879M1, 190177M1, 514276M1, 521282M1, 533326M2	IPTO CLUTH, FRICTION DISC 1,60mm DISCO DE FRICCIÓN DEL EMBRAGUE 1,60mm PTO KAVRAMA BALATASI 1,60mm	
Massey Ferguson MTS 7517	1870004M92	PTO HOUSING CUBO IPTO (TOMA DE POTENCIA INTERNA) PTO TORK GÖVDESİ BOŞ	
Massey Ferguson MTS 7518	1870547M1	PTO HOUSING BUSHING BUJE IPTO (TOMA DE POTENCIA INTERNA) PTO TORK GÖVDESİ BURCU	
Massey Ferguson MTS 7524	1872279M97 1872279M95 1872279M96 19870027M92	IPTO VALVE ASSY. CONJUNTO DE LA VÁLVULA IPTO (TOMA DE POTENCIA INTERNA) PTO TORK KEPÇESİ VALFLİ	
Massey Ferguson MTS 19636	3764018M91	KNUCKLE HOUSING LH MANGUETA DELANTERA IZQUIERDA 4x4 ÖN AKS KOVANI SOL	

MTSCO[®]

Parts Manufacturing





Replacement Tractor Parts
Piezas de Repuesto del Tractor
Traktör Yedek Parçaları

MTSCO Ref.	Part Numbers Números de Pieza Orijinal Parça No.	Description Descripción Ürün Tanımı	Photo Fotografía Fotoğraf
Massey Ferguson MTS 19637	3764016M91	KNUCKLE HOUSING RH MANGUETA DELANTERA DERECHA 4x4 ÖN AKS KOVANI SAĞ	
Massey Ferguson			
Massey Ferguson			
Massey Ferguson			
Massey Ferguson			

MTSCO[®]

Parts Manufacturing





Replacement Tractor Parts
Piezas de Repuesto del Tractor
Traktör Yedek Parçaları

MTSCO Ref.	Part Numbers Números de Pieza Orijinal Parça No.	Description Descripción Ürün Tanımı	Photo Fotografía Fotoğraf
Ford New Holland MTS 0136	83924287 D9NN6A311AD	BALANCER UNIT Utility: 5000 BALANCEADOR COMPLETO Modelo:5000 BALANSİYER 5000	
Ford New Holland MTS 0137	81873989, F1NN6A311AA	BALANCER UNIT Utility: 6610 BALANCEADOR COMPLETO Modelo:6610 BALANSİYER 6610	
Ford New Holland MTS 3265	82858777	BALANCER UNIT Utility: 6640, 7740 BALANCEADOR COMPLETO Modelo:6640,7740 BALANSİYER 6640, 7740	
Ford New Holland MTS 0134	C5NE6A307B	BALANCER HOUSING Empty Utility: 6610 BALANCEADOR Vacío Modelo:6610 BALANSİYER GÖVDESİ 6610	
Ford New Holland MTS 0175	D9NN6B302AB+303AB	BALANCER GEAR SET Z=39 JUEGO ENGRANAJE BALANCEADOR Z=39 BALANSİYER DİŞLİ TK. Z=39	

Replacement Tractor Parts



Piezas de Repuesto del Tractor

Traktör Yedek Parçaları

MTSCO Ref.	Part Numbers Números de Pieza Orijinal Parça No.	Description Descripción Ürün Tanımı	Photo Fotografía Fotoğraf
Ford New Holland MTS 0176	F1NN6B302AA+303AA	BALANCER GEAR SET Z=38 JUEGO ENGRANAJE BALANCEADOR Z=38 BALANSİYER AĞIRLIĞI TK. Z=38	
Ford New Holland MTS 0133	81873999, 83903994, 83955922, E5NN6B302AA, F1NN6B302AA	BALANCER GEAR w/bushing Z=38 16mm ENGRANAJE BALANCEADOR con buje Z=38 16mm BALANS.AĞIRLIĞI BURÇLU Z=38	
Ford New Holland MTS 0132	81839600, 81874001, 83937055, 83955920, E5NN6B303AA, F1NN6B303AA	BALANCER GEAR w/bushing Z=38 16mm ENGRANAJE BALANCEADOR con buje Z=38 16mm BALANS.AĞIRLIĞI BURÇLU Z=38	
Ford New Holland MTS 0131	83924288, D3NN6B302A, D9NN6B302AB	BALANCER GEAR w/bushing Z=39 ENGRANAJE BALANCEADOR con buje Z=39 BALANS.AĞIRLIĞI BURÇLU Z=39	
Ford New Holland MTS 0130	83924289, D3NN6B303A, D9NN6B303AB	BALANCER GEAR w/bushing Z=39 ENGRANAJE BALANCEADOR con buje Z=39 BALANS.AĞIRLIĞI BURÇLU Z=39	

Replacement Tractor Parts
Piezas de Repuesto del Tractor
Traktör Yedek Parçaları

MTSCO Ref.	Part Numbers Números de Pieza Orijinal Parça No.	Description Descripción Ürün Tanımı	Photo Fotografía Fotoğraf
Ford New Holland MTS 0135	81816038 C5NN6A305A	BALANCER DRIVE SHAFT EJE DE TRANSMISIÓN / CONDUCTOR EQUILIBRADOR BALANSİYER MİLİ	
Ford New Holland MTS 0178	87802137	BALANCER THRUST WASHER ARANDELA BALANCEADOR BALANSİYER AĞIRLIK PULU	
Ford New Holland MTS 0146	83956710 87802659 D9NN6529AB	ROCKER ARM, INLET w/srew ENTRADA BALANCIN PIYANO TUŞU CIVATALI	
Ford New Holland MTS 0169	E7NN6549AA	ROCKER ARM SCREW ROCKER BRAZO TORNILLO SUBAP AYAR CIVATASI	
Ford New Holland MTS 0172	D0NN6514A	VALVE SPRING RETAINER RETENEDOR VÁLVULA DE ADMISIÓN SUBAP ŞAPKASI EMME	
Ford New Holland MTS 0138	81811427 C5NE6B306A	CRANKSHAFT PULLEY, SPACER CASQUILLO ESPACIADOR DE CIGÜEÑAL KRANK KEÇE YATAĞI	





MTSCO Ref.	Part Numbers Números de Pieza Orijinal Parça No.	Description Descripción Ürün Tanımı	Photo Fotografía Fotoğraf
Ford New Holland MTS 3148	C5NE6306A	CRANKSHAFT GEAR ENGRANAJE DEL CIGUEÑAL KRANK DİŞLİSİ	
Ford New Holland MTS 3248	87611951	FLYWHEEL HUB VOLANTE DE INERCIA VOLAN KAPAĞI	
Ford New Holland MTS 0150	D3NNN751D D5NNN751D 83908229	PTO, CLUTCH PACK 3 Plate TDF, EMBRAGUE DE ACCIONAMIENTO COMPLETO 3 Placas PTO KAVRAMA KOMPLE 3LÜ	
Ford New Holland MTS 0151	83908229 D2NNN751D D5NNN751A	PTO, CLUTCH PACK 4 Plate TDF, EMBRAGUE DE ACCIONAMIENTO COMPLETO 4 Placas PTO KAVRAMA KOMPLE 4LÜ	
Ford New Holland MTS 0152	83924794 E0NNN751BA	PTO, CLUTCH PACK 5 Plate TDF, EMBRAGUE DE ACCIONAMIENTO COMPLETO 5 Placas PTO KAVRAMA KOMPLE 5Lİ	



Replacement Tractor Parts



Piezas de Repuesto del Tractor

Traktör Yedek Parçaları

MTSCO Ref.	Part Numbers Números de Pieza Orijinal Parça No.	Description Descripción Ürün Tanımı	Photo Fotografía Fotoğraf
Ford New Holland MTS 0153	D3NNN707A	PTO, CLUTCH PACK HOUSING, 3 Plate TDF, EMBRAGUE DE ACCIONAMIENTO HUECO 3 Placas PTO KAVRAMA BOŞ 3LÜ	
Ford New Holland MTS 0154	83903939 D5NNN707A	PTO, CLUTCH PACK HOUSING, 4 Plate TDF, EMBRAGUE DE ACCIONAMIENTO HUECO 4 Placas PTO KAVRAMA BOŞ 4LÜ	
Ford New Holland MTS 0155	E0NNN707AA	PTO, CLUTCH PACK HOUSING, 5 Plate TDF, EMBRAGUE DE ACCIONAMIENTO HUECO 5 Placas PTO KAVRAMA BOŞ 5Lİ	
Ford New Holland MTS 23050	82929714	PTO, CLUTCH PACK HOUSING TDF, EMBRAGUE DE ACCIONAMIENTO HUECO PTO KAVRAMA KUTUSU BOŞ	
Ford New Holland MTS 23051	E0NN7R036AB	PTO, CLUTCH PACK TDF, EMBRAGUE DE ACCIONAMIENTO PTO KAVRAMA KUTUSU DOLU	

MTSCO Ref.	Part Numbers Números de Pieza Orijinal Parça No.	Description Descripción Ürün Tanımı	Photo Fotografía Fotoğraf
Ford New Holland MTS 0156	C9NN7R007A	PTO, DRIVE HOUSING PLATE 6610 PLACA DEL EMBRAGUE DE LA TOMA DE POTENCIA 6610 PTO BASKI VOLANTI 6610	
Ford New Holland MTS 0157	C0NN7B455A	PTO, CLUTCH PRESSURE PLATE 5000 PLACA DEL EMBRAGUE DE LA TOMA DE POTENCIA 5000 PTO BASKI VOLANTI 5000	
Ford New Holland MTS 0158	C0NN7B421A	PTO SNAP RING Big ANILLO DE ENCAJE DE LA TOMA DE POTENCIA Grande PTO BÜYÜK SEGMAN	
Ford New Holland MTS 0159	PBB77517A	PTO SNAP RING small ANILLO DE ENCAJE DE LA TOMA DE POTENCIA Pequeño PTO KÜÇÜK SEGMAN	
Ford New Holland MTS 0161	81565601 81808607 PBB77573A	PTO STEEL PLATE DISCO DE ACERO PLACA DE EMBRAGUE TOMA DE FUERZA PTO SAC PLAKA	

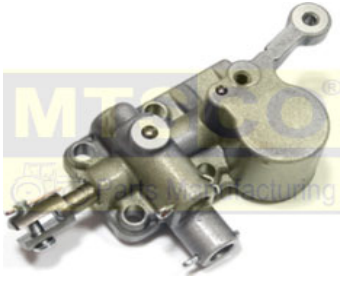
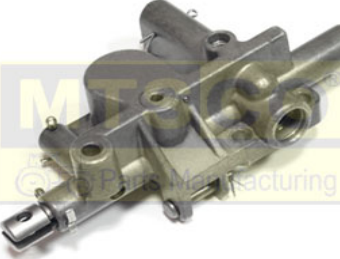
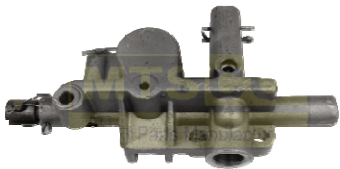



MTSCO Ref.	Part Numbers Números de Pieza Orijinal Parça No.	Description Descripción Ürün Tanımı	Photo Fotografía Fotoğraf
Ford New Holland MTS 0163	81833907 D3NN9733A D3NNP733A	PTO FEATHERING SPRING (Std.) RESORTE DE TRANSMISIÓN (TDF) PTO SARHOŞ SEGMAN	
Ford New Holland MTS 0162	83935173 C0NN7C151A D7NNC732A	PTO REAR CLUTCH PISTON SPRING PISTÓN DEL PAQUETE IPTO (TOMA DE POTENCIA INTERNA) PTO YAYI	
Ford New Holland MTS 0160	81876155, 83900126, D3NNN786A, F1NNN786AA, C5NNN786C, C9NNN786A	PTO REAR CLUTCH PISTON PISTÓN DEL EMBRAGUE PRIMAVERA TDF PTO ALÜMİNYUM PİSTON	
Ford New Holland MTS 0147	81818776 C7NNN776C	PTO SHAFT SUPPORT, w/oil bleed hole EJE DEL SOPORTE DE LA TOMA DE POTENCIA PTO P KEPÇESİ YAĞ DELİKLİ	
Ford New Holland MTS 0148	81826819 C2NNN776A D2NNN776A	PTO SHAFT SUPPORT, w/out oil bleed hole EJE DE SOPORTE IPTO (TOMA DE POTENCIA INTERNA) PTO P KEPÇESİ YAĞ DELİKSİZ	





MTSCO Ref.	Part Numbers Números de Pieza Orijinal Parça No.	Description Descripción Ürün Tanımı	Photo Fotografía Fotoğraf
Ford New Holland MTS 0149	C7NNN700C D2NNN700B 81827441	PTO DRIVE CLUTCH VALVE ASSY. VÁLVULA TOMA DE POTENCIA INTERNA PTO YAĞ OTOMATİK BEYİNCİĞİ	
Ford New Holland MTS 0505	D5NNN700A 83907423	PTO DRIVE CLUTCH VALVE ASSY. 7600 CONJUNTO DE LA VÁLVULA IPTO (TOMA DE POTENCIA INTERNA) 7600 PTO BEYİNCİK 7600	
Ford New Holland MTS 23105	E0NNN700AD 83955509	PTO DRIVE CLUTCH VALVE ASSY. 7610 VÁLVULA TOMA DE POTENCIA INTERNA 7610 PTO BEYİNCİK 7610	
Ford New Holland MTS 35174	82989498 47584108 F0NNN700AB F0NNN700AA 81865568	PTO DRIVE CLUTCH VALVE ASSY. VÁLVULA TOMA DE POTENCIA INTERNA PTO BEYİNCİK	
Ford New Holland MTS 23108	81863036	PTO VALVE ASSY. TDF VÁLVULA DOBLE POTENCIA PTO BEYİNCİK	

Replacement Tractor Parts

Piezas de Repuesto del Tractor

Traktör Yedek Parçaları

MTSCO Ref.	Part Numbers Números de Pieza Orijinal Parça No.	Description Descripción Ürün Tanımı	Photo Fotografía Fotoğraf
Ford New Holland MTS 7761	47133081	PTO SHAFT Z=6 EJE TOMA DE FUERZA Z=6 KUYRUK MİLİ Z=6	
Ford New Holland MTS 7762	47133076	PTO SHAFT Z=21 EJE TOMA DE FUERZA Z=21 KUYRUK MİLİ Z=21	
Ford New Holland MTS 0144	D5NNN960B	FLOW CONTROL VALVE, SEAT small ASIENTO DE LA VÁLVULA DE CONTROL DE FLUJO pequeño HİD.SİLİNDİR SEÇİCİ VALFİ KÜÇÜK	
Ford New Holland MTS 0173	83906348, 83924886, C5NND960C, C5NND960D, E0NND960AA	SELECTOR VALVE ASSY. SERVICIO EXTERNO DE LA VÁLVULA DAMPER VALFİ	
Ford New Holland MTS 8396	E2NNR841BA 83952853	PRIORITY VALVE SPOOL SOLENOIDE DE LA VÁLVULA DE PRIORIDAD HİDROLİK ÖNCELİK VALFİ	

MTSCO Ref.	Part Numbers Números de Pieza Orijinal Parça No.	Description Descripción Ürün Tanımı	Photo Fotografía Fotoğraf
Ford New Holland MTS 0177	E1NN3N503BC C7NN3N503D 83954900	HYD. STEERING GEAR ASSY. CONJUNTO DE LA CAJA DE DIRECCIÓN HIDRÁULICA DE POTENCIA HİD.DİREKSİYON	
Ford New Holland MTS 0479	EDPN3500A	HYD.STEERING GEAR ASSY.REP.KIT JUEGO DE SELLOS DE LA CAJA DE DIRECCIÓN DE POTENCIA HİD.DİREKSİYON TM.TK.	
Ford New Holland MTS 0379	-	HYD. STEERING HOUSING ASSY. CARCASA DEL ENGRANAJE DE DIRECCIÓN HIDRÁULICA HİD.DİREKSİYON KUTUSU	
Ford New Holland MTS 0380	C9NN3N583B	HYD. STEERING HOUSING COVER CUBIERTA DE LA CAJA DE DIRECCIÓN HIDRÁULICA HİD.DİREKSİYON KUTUSU KAPAĞI	
Ford New Holland MTS 0381	-	HYD.STEERING HOUSING ADAPTER LOWER CARCASA DEL ENGRANAJE DE DIRECCIÓN HIDRÁULICA INFERIOR HİD.DİR.VALFİ	

MTSCO Ref.	Part Numbers Números de Pieza Orijinal Parça No.	Description Descripción Ürün Tanımı	Photo Fotografía Fotoğraf
Ford New Holland MTS 0382	-	HYD.STEERING HOUSING ADAPTER UPPER CARCASA DEL ENGRANAJE DE DIRECCIÓN HIDRÁULICA SUPERIOR HİD.DİR.KONTROL VALFİ	
Ford New Holland MTS 0383	E1NN3C529AA	HYD.STEERING COLUMN COLUMNA DE DIRECCIÓN HIDRÁULICA HİD.DİR.MİL KOVANI	
Ford New Holland MTS 0384	C9NN3575B	HYD.STEERING SHAFT EJE DE DIRECCIÓN HIDRÁULICO HİD.DİR.SEKTÖR DİŞLİSİ	
Ford New Holland MTS 0385	-	HYD.STEERING SHAFT LOWER EJE DE DIRECCIÓN HIDRÁULICO INFERIOR HİD.DİR.MİLİ ALT	
Ford New Holland MTS 0141	-	HYD.STEERING SHAFT SLEEVE ANILLO DEL EJE DE DIRECCIÓN HIDRÁULICA HİD.MİL SEGMANI	

Replacement Tractor Parts

Piezas de Repuesto del Tractor

Traktör Yedek Parçaları





MTSCO Ref.	Part Numbers Números de Pieza Orijinal Parça No.	Description Descripción Ürün Tanımı	Photo Fotografía Fotoğraf
Ford New Holland MTS 0386	C9NN3E612A	HYD.STEERING SHAFT RING ANILLO DE COJINETE / RODAMIENTO HİD.DİR.BİLYA YATAĞI	
Ford New Holland MTS 0179	-	HYD.STEERING SHAFT UPPER EJE DE DIRECCIÓN HIDRÁULICA SUPERIOR HİD.DİR.MİLİ ÜST	
Ford New Holland MTS 0142	86585243 E4NN3R686AA	HYD.STEERING TENSION ROD BARRA TENSION DE LA DIRECCIÓN HIDRÁULICA HİD.DİR.TANSİYON ÇUBUĞU	
Ford New Holland MTS 18271	81822006 83907562 83929295 C9NN3R662A D5NN3N632A E1NN3N632AA	HYD.STEERING OIL SEAL VITON SELLO DE LA COLUMNA DE DIRECCIÓN VITON HİDROLİK DİREKSİYON KEÇESİ VİTON	
Ford New Holland MTS 18272	81822006-E 83907562-E 83929295-E C9NN3R662A-E D5NN3N632A-E E1NN3N632AA-E	HYD.STEERING OIL SEAL NBR SELLO DE LA COLUMNA DE DIRECCIÓN NBR HİDROLİK DİREKSİYON KEÇESİ NBR	





MTSCO Ref.	Part Numbers Números de Pieza Orijinal Parça No.	Description Descripción Ürün Tanımı	Photo Fotografía Fotoğraf
Ford New Holland MTS 0139	81818792 C5NN2466D C7NN2466B	BRAKE ACTUATOR ROD VARILLA DEL FRENO KEÇE MİLİ KISA 5000	
Ford New Holland MTS 0140	C5NN2466B	BRAKE ACTUATOR ROD VARILLA DEL FRENO F.KÖRÜKLÜ KEÇE MİLİ	
Ford New Holland MTS 19630	CASE-IH 81291C1 // FORD 83949040, 9361240 // ZF4472352095 // ZP4472352117	KNUCKLE HOUSING LH MANGUETA DELANTERA IZQUIERDA 4x4 ÖN AKS KOVANI SOL	
Ford New Holland MTS 19631	CASE-IH 81292C1 // FORD 83949041, 9361424 // ZF4472352096 // ZP4472352118	KNUCKLE HOUSING RH MANGUETA DELANTERA DERECHA 4x4 ÖN AKS KOVANI SAĞ	
Ford New Holland MTS 19632	CASE-IH 81666C1 // FORD 83949043 // ZF4472353311	KNUCKLE HOUSING LH MANGUETA DELANTERA IZQUIERDA 4x4 ÖN AKS KOVANI SOL	

Replacement Tractor Parts

Piezas de Repuesto del Tractor

Traktör Yedek Parçaları

MTSCO Ref.	Part Numbers Números de Pieza Orijinal Parça No.	Description Descripción Ürün Tanımı	Photo Fotografía Fotoğraf
Ford New Holland MTS 19633	CASE-IH 81665C1 // FORD 83949042 // ZF4472353310	KNUCKLE HOUSING RH MANGUETA DELANTERA DERECHA 4x4 ÖN AKS KOVANI SAĞ	
Ford New Holland MTS 19590	87618799	4X4 FRONT AXLE DRIVE SHAFT HOUSING 4x4 CARCASA EJE DELANTERO 4X4 ÖN AKS ŞAFT KOVANI	
Ford New Holland MTS 19380	82850291 17577 128880 122260A1 3541417M1 9968023	KING PIN PIVOTE DIRECCIÓN AKS KOVAN PİMİ	
Ford New Holland MTS 19381	82850292 17576 128881 122259A1 3523550M1 9968025	KING PIN PIVOTE DIRECCIÓN AKS KOVAN PİMİ	
Ford New Holland MTS 19382	87333763	KING PIN PIVOTE INFERIOR AKS KOVAN PİMİ	

MTSCO Ref.	Part Numbers Números de Pieza Orijinal Parça No.	Description Descripción Ürün Tanımı	Photo Fotografía Fotoğraf
Ford New Holland MTS 0145	81814506 C5NN3N703C	CENTRE ARM STEERING SHAFT EJE CENTRAL DEL BRAZO DE DIRECCIÓN ÖN SPORT ÇOLAK PİMİ	
Ford New Holland MTS 7965	E2NN4684AA	COUPLING Z=23, 160mm ACOPLAMIENTO DE REDONDA Z=23, 160mm KAPLİN, FREZELİ Z=23, 160mm	
Ford New Holland MTS 26066	82026659	HYDRAULIC LIFT ARM LH BRAZO ELEVADOR HIDRÁULICO IZQUIERDA HİDROLİK KALDIRMA KOLU SOL	
Ford New Holland MTS 26067	81865122	HYDRAULIC LIFT ARM RH BRAZO ELEVADOR HIDRÁULICO DERECHA HİDROLİK KALDIRMA KOLU SAĞ	
Ford New Holland MTS 9796	87543516	FENDER MOUNTING BRACKET SOPORTE DE GUARDABARROS ÇAMURLUK BAĞLANTI BRAKETİ	





MTSCO[®]

Parts Manufacturing

Replacement Tractor Parts



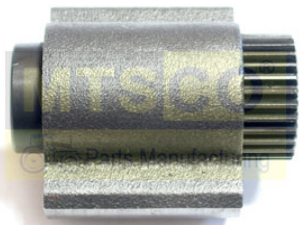

Piezas de Repuesto del Tractor

Traktör Yedek Parçaları

MTSCO Ref.	Part Numbers Números de Pieza Orijinal Parça No.	Description Descripción Ürün Tanımı	Photo Fotografía Fotoğraf	
FIAT New Holland	MTS 0222	4813283	BALANCER UNIT New Model BALANCEADOR COMPLETO Nuevo Modelo BALANSİYER	
FIAT New Holland	MTS 0223	4792111	BALANCER HOUSING w/Bushing BALANCEADOR Vacío con buje BALANSİYER GÖVDESİ, BURÇLU	
FIAT New Holland	MTS 12120	500374916	BALANCER UNIT Utility: TD90D BALANCEADOR COMPLETO Modelo: TD90D BALANSİYER TD90D	
FIAT New Holland	MTS 12122	99441704	BALANCER WEIGHT w/bushing PESO DE BALANCEADOR con buje BLNS.AĞ.TK.(BURÇ DİŞLİ MİL AĞIRLIK)	
FIAT New Holland	MTS 12124	98415090	BALANCER GEAR ENGRANAJE DE BALANCEADOR BALANSİYER PRİZDİREK MİLİ	

Original Manufacturer names, part numbers and descriptions are quoted for reference purposes ONLY.
It is NOT implied that these parts supplied by ourselves are used as original equipment.

Replacement Tractor Parts
Piezas de Repuesto del Tractor
Traktör Yedek Parçaları

MTSCO Ref.	Part Numbers Números de Pieza Orijinal Parça No.	Description Descripción Ürün Tanımı	Photo Fotografía Fotoğraf
FIAT New Holland MTS 0225	4678406	BALANCER BUSH BUJE BALANCEADOR BALANSİYER DELİKLİ BURÇ	
FIAT New Holland MTS 0238	4789410	BALANCER WEIGHT w/bushing KIT JUEGO DE PESO DE BALANCEADOR con buje BLNS.AĞ.TK.(BURÇ DİŞLİ MİL AĞIRLIK)	
FIAT New Holland MTS 0228	585314	BALANCER GEAR BUSH BUJE DE ENGRANAJE BALANCEADOR BALANSİYER AĞIRLIK BURCU	
FIAT New Holland MTS 0324	4600367	BALANCER SHAFT EJE CONDUCTOR EQUILIBRADOR BALANSİYER AĞIRLIK MİLİ	
FIAT New Holland MTS 0231	4600376	BALANCER IDLER GEAR w/bushing CASE CORONA ENGRANAJE con buje BALANS.ORTA AVARE DİŞLİSİ, BURÇLU	

Replacement Tractor Parts

Piezas de Repuesto del Tractor





Traktör Yedek Parçaları



MTSCO Ref.	Part Numbers Números de Pieza Orijinal Parça No.	Description Descripción Ürün Tanımı	Photo Fotografía Fotoğraf	
FIAT New Holland	MTS 0232	4628982	BALANCER IDLER GEAR BUSH BUJE DE ENGRANAJE BALANCEADOR BALANS.ORTA AVARE DİŞLİ BURCU	
FIAT New Holland	MTS 0224	4788666	BALANCER SHAFT EJE CONDUCTOR EQUILIBRADOR BALANSİYER KISA MİL	
FIAT New Holland	MTS 0226	4605610	BALANCER GEAR ENGRANAJE DE BALANCEADOR BALANSİYER PRİZDİREK MİLİ	
FIAT New Holland	MTS 0248	4770244	BALANCER TIMING GEAR ENGRANAJE DE SINCRONIZACIÓN DEL BALANCEADOR BALANSİYER ZAMAN DİŞLİSİ MİLİ L=102 Z=27	
FIAT New Holland	MTS 0229	4600375	BALANCER SUPPORT APOYO DE EQUILIBRIO BALANS.PİRİZ. MERKEZ KAPAĞI	

Replacement Tractor Parts



Piezas de Repuesto del Tractor

Traktör Yedek Parçaları

MTSCO Ref.	Part Numbers Números de Pieza Orijinal Parça No.	Description Descripción Ürün Tanımı	Photo Fotografía Fotoğraf
FIAT New Holland MTS 0230	4607851	BALANCER SUPPORT BUSH BUJE DE APOYO DE EQUILIBRIO BALANS.PİRİZ. KAPAK BURCU	
FIAT New Holland MTS 0220	588771 Long (USA): TX11266	DISTRIBUTOR w/short lever CORPO DISTRIBUIDOR DE DOBLE SALIDA con palanca corta DAMPER ÇİFT ÇIKIŞ KISA KOLLU	
FIAT New Holland MTS 0220/A	588771 Long (USA): TX11266	DISTRIBUTOR w/short lever, and w/plug kit CORPO DISTRIBUIDOR DE DOBLE SALIDA con palanca corta y juego de enchufe DAMPER ÇİFT ÇIKIŞ KISA KOLLU REKORLU	
FIAT New Holland MTS 0233	5088259	DISTRIBUTOR w/long lever CORPO DISTRIBUIDOR DE DOBLE SALIDA con palanca larga DAMPER ÇİFT ÇIKIŞ UZUN KOLLU	

MTSCO Ref.	Part Numbers Números de Pieza Orijinal Parça No.	Description Descripción Ürün Tanımı	Photo Fotografía Fotoğraf
FIAT New Holland MTS 0233/A	5088259	DISTRIBUTOR w/long lever and w/plug kit CORPO DISTRIBUIDOR DE DOBLE SALIDA con palanca larga y juego de enchufe DAMPER ÇİFT ÇIKIŞ UZUN KOLLU, REKORLU	
FIAT New Holland MTS 0221	549631	DISTRIBUTOR LEVER short PALANCA DE DISTRIBUIDOR corto DAMPER KOLU KISA	
FIAT New Holland MTS 0234	-	DISTRIBUTOR LEVER long PALANCA DE DISTRIBUIDOR largo DAMPER KOLU UZUN	
FIAT New Holland MTS 0237	-	DISTRIBUTOR PLUG KIT JUEGO DE ENCHUFE DISTRIBUIDOR DAMPER REKOR TAKIMI	





Replacement Tractor Parts
Piezas de Repuesto del Tractor
Traktör Yedek Parçaları

MTSCO Ref.	Part Numbers Números de Pieza Orijinal Parça No.	Description Descripción Ürün Tanımı	Photo Fotografía Fotoğraf	
FIAT New Holland	MTS 26115	5198501	ROCKSHAFT EJE DE ROCAS HİDROLİK FREZELİ MİL	
FIAT New Holland	MTS 19638	5126626	KNUCKLE HOUSING LH MANGUETA DELANTERA IZQUIERDA 4x4 ÖN AKS KOVANI SOL	
FIAT New Holland	MTS 19639	5126627	KNUCKLE HOUSING RH MANGUETA DELANTERA DERECHA 4x4 ÖN AKS KOVANI SAĞ	
FIAT New Holland				
FIAT New Holland				

Replacement Tractor Parts

Piezas de Repuesto del Tractor





Traktör Yedek Parçaları

MTSCO Ref.	Part Numbers Números de Pieza Orijinal Parça No.	Description Descripción Ürün Tanımı	Photo Fotografía Fotoğraf
DEUTZ - FAHR	MTS 0261	02940278 04357435 04360637 MAIN HYDRAULIC CONTROL UNIT VALVULA DE CONTROL SISTEMA ELEVADOR BEYİNCİK	
DEUTZ - FAHR	MTS 0250	223 8382 04230657 BALANCER UNIT COJINETE DE LA UNIDAD DEL CONTRAPESO BALANSİYER	
DEUTZ - FAHR	MTS 0251	223 6492 223 6983 BALANCER HOUSING TAPA DE BALANCEDOR DE 2 AGUJEROS BALANSİYER 2 DELİKLİ KOL	
DEUTZ - FAHR	MTS 0252	223 6977 223 6999 BALANCER HOUSING TAPA DE BALANCEDOR DE 3 AGUJEROS BALANSİYER 3 DELİKLİ KOL	
DEUTZ - FAHR	MTS 0253	223 6476 BALANCER GEAR ENGRANAJE DE BALANCEADOR BALANSİYER ÇANAK DİŞLİ	



Replacement Tractor Parts

Piezas de Repuesto del Tractor

Traktör Yedek Parçaları

MTSCO Ref.	Part Numbers Números de Pieza Orijinal Parça No.	Description Descripción Ürün Tanımı	Photo Fotografía Fotoğraf	
DEUTZ - FAHR	MTS 0254	223 2168	BALANCER WEIGHT PESO DE BALANCEADOR / EQUILIBRADOR BALANSİYER AĞIRLIĞI	
DEUTZ - FAHR	MTS 0263	213 5196	SHIM 0,3mm SEPARADOR 0,3mm BALANSİYER ŞİMİ 0,3mm	
DEUTZ - FAHR	MTS 0264	223 6511	SHIM 0,1mm SEPARADOR 0,1mm BALANSİYER ŞİMİ 0,1mm	
DEUTZ - FAHR	MTS 6580	0339 3285	BRAKE DRUM FRENO DE TAMBOR FREN KAMPANASI	
DEUTZ - FAHR	MTS 6581	0431 3624	BRAKE DRUM FRENO DE TAMBOR FREN KAMPANASI	

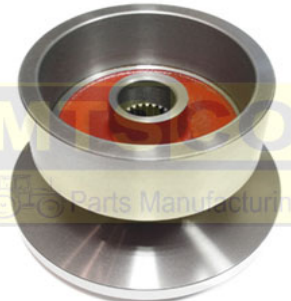
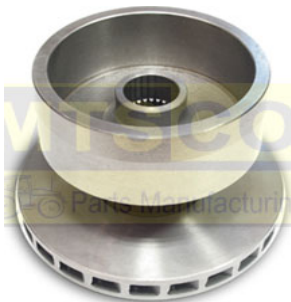
Replacement Tractor Parts
Piezas de Repuesto del Tractor
Traktör Yedek Parçaları

MTSCO Ref.	Part Numbers Números de Pieza Orijinal Parça No.	Description Descripción Ürün Tanımı	Photo Fotografía Fotoğraf	
DEUTZ - FAHR	MTS 6582	0432 3315	BRAKE DRUM FRENO DE TAMBOR FREN KAMPANASI	
DEUTZ - FAHR	MTS 6583	0438 4112	BRAKE DRUM FRENO DE TAMBOR FREN KAMPANASI	
DEUTZ - FAHR	MTS 6584	0438 9839	BRAKE DRUM LH FRENO DE TAMBOR IZQUIERDA FREN KAMPANASI SOL	
DEUTZ - FAHR	MTS 6585	0438 9840	BRAKE DRUM RH FRENO DE TAMBOR DERECHA FREN KAMPANASI SAĞ	
DEUTZ - FAHR	MTS 6586	0231 3904	BRAKE DRUM FRENO DE TAMBOR FREN KAMPANASI	

MTSCO[®]

Parts Manufacturing

Replacement Tractor Parts

Piezas de Repuesto del Tractor

Traktör Yedek Parçaları

MTSCO Ref.	Part Numbers Números de Pieza Orijinal Parça No.	Description Descripción Ürün Tanımı	Photo Fotografía Fotoğraf
DEUTZ - FAHR	MTS 6587	0238 2441 BRAKE DRUM FRENO DE TAMBOR FREN KAMPANASI	
DEUTZ - FAHR	MTS 19383	0255 43350 025543350 0.255.4335.0/10 0.255.4335.0 02554335010 72704279 6450-224 KING PIN PIVOTE SUPERIOR AKS KOVAN PİMİ	
DEUTZ - FAHR			
DEUTZ - FAHR			
DEUTZ - FAHR			

MTSCO Ref.	Part Numbers Números de Pieza Orijinal Parça No.	Description Descripción Ürün Tanımı	Photo Fotografía Fotoğraf
CASE-IH MTS 0240	3132895R93, 3132874R91, 3132874R92, 3132874R93, 3228366R91, 3132895R92, 3132895R91, 3132874R94	BALANCER UNIT Utility: D239 BALANCEADOR COMPLETO Modelo: D239 BALANSİYER D239	
CASE-IH MTS 0241	3055501R94	BALANCER UNIT Utility: D206 BALANCEADOR COMPLETO Modelo: D206 BALANSİYER D206	
CASE-IH MTS 28181	119656A1	COMPENSATOR VALVE REP.KIT JUEGO DE REPARACIÓN VÁLVULA COMPENSACIÓN HİD.BASINÇ AYAR VALFİ TM.TK.	
CASE-IH MTS 0398	90031C2	TRANSFER GEARBOX COUPLING Z=21 ACOPLE ESTRÍADO DE 21 ESTRÍAS MESNET Z=21	
CASE-IH MTS 0399	90030C2	TRANSFER GEARBOX COUPLING Z=24 ACOPLE ESTRÍADO DE 24 ESTRÍAS MESNET Z=24	

Replacement Tractor Parts

Piezas de Repuesto del Tractor

Traktör Yedek Parçaları

MTSCO Ref.	Part Numbers Números de Pieza Orijinal Parça No.	Description Descripción Ürün Tanımı	Photo Fotografía Fotoğraf	
CASE-IH	MTS 19810	90088C1	TRANSFER GEARBOX COUPLING STUD TORNILLO CARDÁN MESNET CIVATASI	
CASE-IH	MTS 7766	47130743 5182612	PTO SHAFT Z=6 EJE TOMA DE FUERZA Z=6 KUYRUK MİLİ Z=6	
CASE-IH	MTS 7767	47130744 5182613	PTO SHAFT Z=21 EJE TOMA DE FUERZA Z=21 KUYRUK MİLİ Z=21	
CASE-IH	MTS 0246	94809C3 94809C2 94809C1	COVER ASSEMBLY PARK LOCK TAPA DE TRANSMISIÓN TRASERA SEMER	
CASE-IH	MTS 35206	181199A4	TRANSMISSION PUMP BOMBA TRANSMISIÓN ŞANZIMAN POMPASI	

Replacement Tractor Parts

Piezas de Repuesto del Tractor



Traktör Yedek Parçaları

MTSCO Ref.	Part Numbers Números de Pieza Orijinal Parça No.	Description Descripción Ürün Tanımı	Photo Fotografía Fotoğraf	
UTB	MTS 0325	12101056	BALANCER UNIT Utility: 640 BALANCEADOR COMPLETO Modelo: 640 BALANSİYER 640	
UTB	MTS 0352	12101052	BALANCER WEIGHT w/Bushing Utility:640 PESO DE BALANCEADOR con buje Modelo:640 640 BLNS.AĞIRLIK KOMPLE	
UTB	MTS 0353	12101054	BALANCER WEIGHT SHAFT Utility:640 EJE FLAUTA BALANCINES Modelo: 640 640 BLNS.AĞIRLIK MİLİ	
UTB	MTS 0354	12101029	BALANCER IDLER GEAR w/Bushing Utility:640 CASE CORONA ENGRANAJE con buje Modelo: 640 640 BLNS.ORTA AVARE DİŞLİSİ	
UTB	MTS 0355	12101196	BALANCER GEAR Utility:640 ENGRANAJE BALANCEADOR Modelo:640 640 BLNS.PRİZD.DİŞLİSİ KAMALI	

MTSCO[®]

Parts Manufacturing

Replacement Tractor Parts
Piezas de Repuesto del Tractor
Traktör Yedek Parçaları

MTSCO Ref.	Part Numbers Números de Pieza Orijinal Parça No.	Description Descripción Ürün Tanımı	Photo Fotografía Fotoğraf	
UTB	MTS 0356	12101206	BALANCER GEAR Utility:640 ENGRANAJE DE BALANCEADOR Modelo: 640 640 BLNS.PRİZDİREK MİLİ	
UTB	MTS 3425	11008012	OIL PUMP BOMBA DE ACEITE YAĞ POMPASI	
UTB				
UTB				
UTB				

Original Manufacturer names, part numbers and descriptions are quoted for reference purposes ONLY.
It is NOT implied that these parts supplied by ourselves are used as original equipment.

MTSCO®

Parts Manufacturing

Replacement Tractor Parts
Piezas de Repuesto del Tractor
Traktör Yedek Parçaları



MTSCO Ref.	Part Numbers Números de Pieza Orijinal Parça No.	Description Descripción Ürün Tanımı	Photo Fotografía Fotoğraf
LANDINI MTS 26432	3306467M91, 3306467M92, 3306467M93, 3306467M94, 3306467M95, 3306467M96, 3306467M97, 3306467M98, 3306467M99, CASTING NO.1425364M1, 87289111, 87289653	HYDRAULIC CONTROL VALVE VÁLVULA DE CONTROL HÍDRÁULICO HİD.KONTROL VALFİ	
LANDINI MTS 7608	3549334M3	PTO SHAFT Z=6 EJE TOMA DE FUERZA Z=6 KUYRUK MİLİ Z=6	
LANDINI MTS 7609	3552071M3	PTO SHAFT Z=21 EJE TOMA DE FUERZA Z=21 KUYRUK MİLİ Z=21	
LANDINI			
LANDINI			

Original Manufacturer names, part numbers and descriptions are quoted for reference purposes ONLY.
It is NOT implied that these parts supplied by ourselves are used as original equipment.

MTSCO®

Parts Manufacturing

Replacement Tractor Parts
Piezas de Repuesto del Tractor
Traktör Yedek Parçaları

MTSCO Ref.	Part Numbers Números de Pieza Orijinal Parça No.	Description Descripción Ürün Tanımı	Photo Fotografía Fotoğraf
VALTRA MTS 7750	31813100	PTO SHAFT Z=6 / 540 RPM EJE TOMA DE FUERZA Z=6 / 540 RPM KUYRUK MİLİ Z=6 / 540 RPM	
VALTRA MTS 7751	33656200	PTO SHAFT Z=21 / 1000 RPM EJE TOMA DE FUERZA Z=21 / 1000 RPM KUYRUK MİLİ Z=21 / 1000 RPM	
VALTRA			
VALTRA			
VALTRA			

Original Manufacturer names, part numbers and descriptions are quoted for reference purposes ONLY.
It is NOT implied that these parts supplied by ourselves are used as original equipment.